

Nr.

3. Auflage

... der greifbare Unterschied

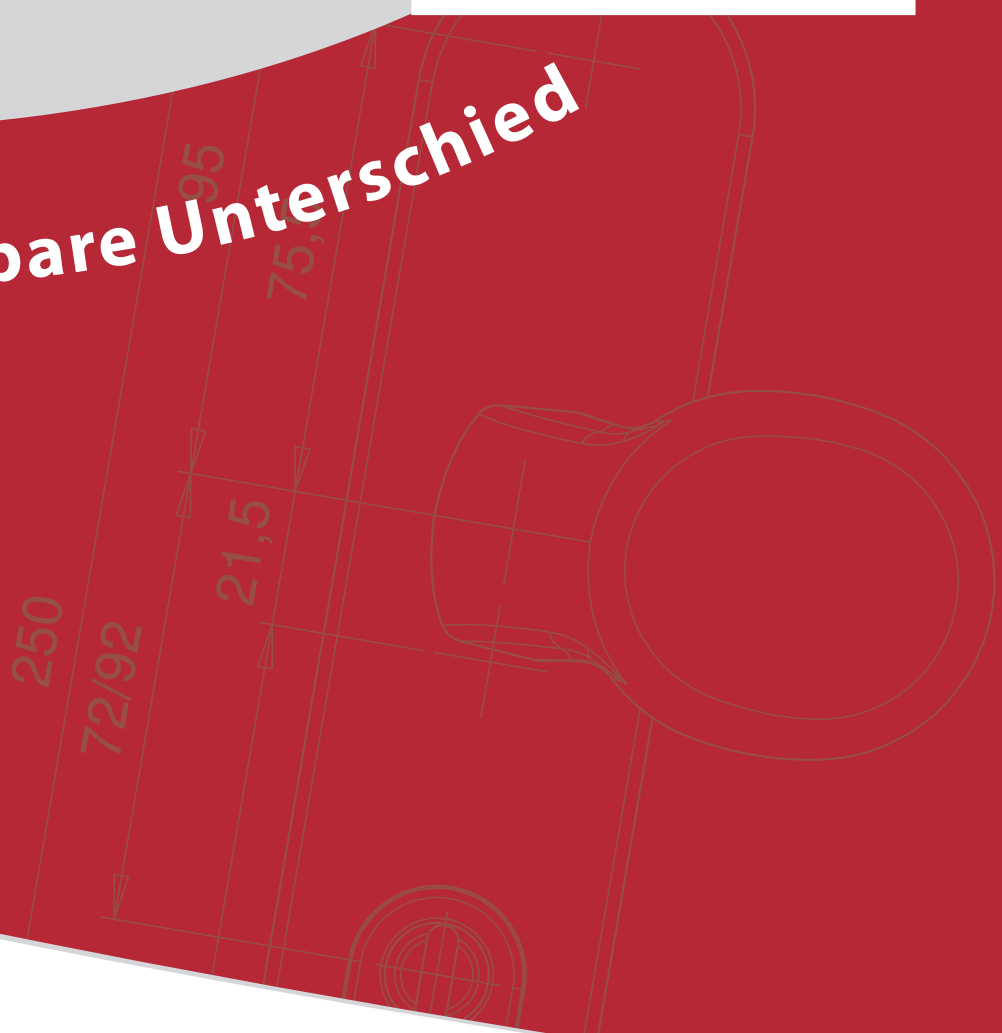

Beschläge für Innentüren

BESCHLÄGE FÜR INNENTÜREN



edi

7	BESCHLÄGE FÜR INNENTÜREN	Seiten 225 - 258
7.1	Drücker, Schilder, Rosetten und Knöpfe	232 - 251
7.2	Komplettgarnituren Aluminium im Schrumpfpack	252 - 255
7.3	Komplettgarnituren Nylon (incl. Feuerschutz- und Fluchttürgarnituren)	256 - 258

7.1 TÜRDRÜCKER

Seiten 232 - 236



7.1 ROSETTEN

Seiten 238 - 239



7.1 TÜRKNÖPFE

Seiten 240 - 243

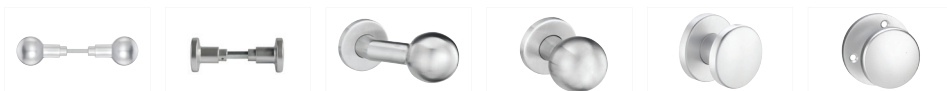

7.1 TÜRSCHILDER

Seiten 244 - 251



7.2 KOMPLETTGARNITUREN ALUMINIUM

Seiten 252 - 255



7.3 KOMPLETTGARNITUREN NYLON (incl. Feuerschutz- und Fluchttürgarnituren) Seiten 256 - 258

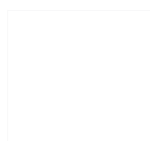









EINZELTEILVERSORGUNG

DAS **PROFI-BASIS-SORTIMENT** ALS
BAUKASTENSYSTEM

PROBLEMLÖSER MADE IN GERMANY
vertrauen Sie auf die Kompetenz eines Herstellers,
denn oft geht es um mehr als das Standardprodukt.

◆ Material:	Aluminium eloxiert oder Edelstahl matt gebürstet
◆ Drückerpaare:	Stiftteil-/Lochteil-Kombination
◆ Schilder:	gestanzt
◆ WC-Schilder:	mit Rot-Weiß-Scheibe
◆ Knopfschilder:	mit fest vertaumatem Knopf
◆ Grundkonstruktion Premiumrosetten:	Stahl
◆ Stütznocken Außenrosette:	Stahl Ø 8 mm
◆ Innenrosette:	Premiumrosette mit Durchgangsnocken
◆ Verschraubung:	M5, verdeckt
◆ Rosetten-Ø:	55 mm
◆ WC-Rosetten:	mit Rot-Weiß-Scheibe
◆ Grundkonstruktion Standardrosetten:	Kunststoff
◆ Stütznocken:	zur gegenseitigen Verschraubung 4x45 mm, verdeckt
◆ Rosetten-Ø:	55 mm
◆ WC-Rosetten:	mit Rot-Weiß-Scheibe
◆ Grundkonstruktion Knöpfe:	fest bzw. fest-drehbar (s. Artikelbezeichnung) auf Stahlunterkonstruktion
◆ Grundkonstruktion Knopfdrückerpaare:	Stiftteil-/Lochteil-Kombination

Bestellinformationen für die abgebildeten Sonderschilder auf den Seiten 249 + 251.

						
Langschild 237 BL	Langschild 237 ODL	Langschild 237 OSL	Kurzschild 236 BL	Kurzschild 236 ODL	Kurzschild 236 OSL	Knopfkurzschild 336 OSL

7.1 TÜRDRÜCKER

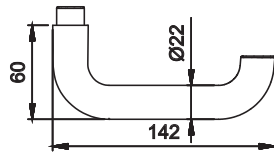

F1	F2
EST	

INFOthek



Zt.-Drückerpaare TS 35-45 mm
Ht.-Drückerpaare TS 65-75 mm.

Abweichungen von Standard-TS bitte gesondert bestellen.

	ARTIKELBEZEICHNUNG	DR. FORM	■	BESTELL-NR.	VE
	Drückerpaar Drückerpaar	103Z 103H	8 mm 10 mm	1103/0808 2103/1008	10 Pr. 10 Pr.
	Drückerlochteil Drückerlochteil	103Z 103H	8 mm 10 mm	1103/0809 2103/1009	10 St. 10 St.

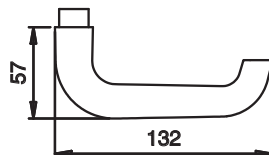

F1	F2
F3	F4

INFOthek



Zt.-Drückerpaare TS 35-45 mm
Ht.-Drückerpaare TS 65-75 mm.

Abweichungen von Standard-TS bitte gesondert bestellen.

Passender Haustürdrücker
Form 103.

	ARTIKELBEZEICHNUNG	DR. FORM	■	BESTELL-NR.	VE
	Drückerpaar	104Z	8 mm	1104/0808	10 Pr.
	Drückerlochteil	104Z	8 mm	1104/0809	10 St.

7.1 TÜRDRÜCKER

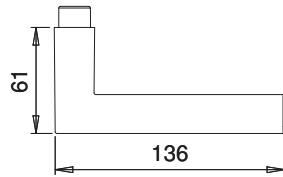
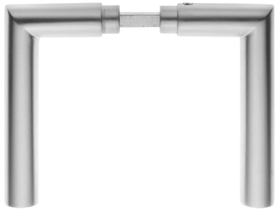

F1	EST

INFOthek



Zt-Drückerpaare TS 35-45 mm
Ht-Drückerpaare TS 65-75 mm.

Abweichungen von Standard-TS bitte gesondert bestellen.

	ARTIKELBEZEICHNUNG	DR. FORM	■	BESTELL-NR.	VE
	Drückerpaar Drückerpaar	108Z 108H	8 mm 10 mm	1108/0808 2108/1008	10 Pr. 10 Pr.
	Drückerlochteil Drückerlochteil	108Z 108H	8 mm 10 mm	1108/0809 2108/1009	10 St. 10 St.

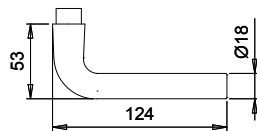

F1	

INFOthek



Zt-Drückerpaare TS 35-45 mm
Ht-Drückerpaare TS 65-75 mm.

Abweichungen von Standard-TS bitte gesondert bestellen.

	ARTIKELBEZEICHNUNG	DR. FORM	■	BESTELL-NR.	VE
	Drückerpaar	110Z	8 mm	1110/0808	10 Pr.
	Drückerlochteil	110Z	8 mm	1110/0809	10 St.

7.1 TÜRDRÜCKER

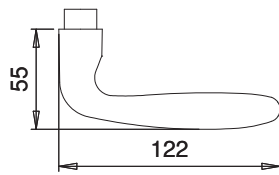

F1	

INFOthek



Zt-Drückerpaare TS 35-45 mm
Ht-Drückerpaare TS 65-75 mm.

Abweichungen von Standard-TS bitte gesondert bestellen.

	ARTIKELBEZEICHNUNG	DR. FORM	■	BESTELL-NR.	VE
	Drückerpaar	112Z	8 mm	1112/0808	10 Pr.
	Drückerlochteil	112Z	8 mm	1112/0809	10 St.

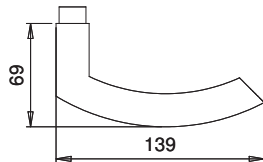

F1	

INFOthek



Zt-Drückerpaare TS 35-45 mm
Ht-Drückerpaare TS 65-75 mm.

Abweichungen von Standard-TS bitte gesondert bestellen.

	ARTIKELBEZEICHNUNG	DR. FORM	■	BESTELL-NR.	VE
	Drückerpaar	113Z	8 mm	1113/0808	10 Pr.
	Drückerlochteil	113Z	8 mm	1113/0809	10 St.

7.1 TÜRDRÜCKER

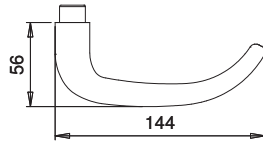

F1	EST

INFOthek



Zt-Drückerpaare TS 35-45 mm
Ht-Drückerpaare TS 65-75 mm.

Abweichungen von Standard-TS bitte gesondert bestellen.

	ARTIKELBEZEICHNUNG	DR. FORM	■	BESTELL-NR.	VE
	Drückerpaar	114Z	8 mm	1114/0808	10 Pr.
	Drückerlochteil	114Z	8 mm	1114/0809	10 St.

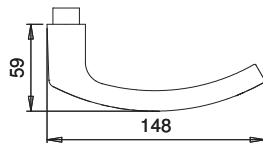

F1	F9

INFOthek



Zt-Drückerpaare TS 35-45 mm
Ht-Drückerpaare TS 65-75 mm.

Abweichungen von Standard-TS bitte gesondert bestellen.

	ARTIKELBEZEICHNUNG	DR. FORM	■	BESTELL-NR.	VE
	Drückerpaar	2000Z	8 mm	2000/0808	8 Pr.
	Drückerlochteil	2000Z	8 mm	2000/0809	8 St.

7.1 TÜRDRÜCKER

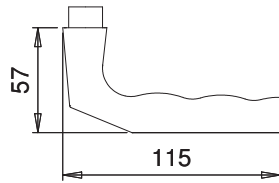
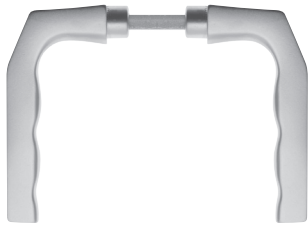

F1	F2
F3	F4
F5*	F9*



INFOthek



Zt-Drückerpaare TS 35-45 mm
Ht-Drückerpaare TS 65-75 mm.

Abweichungen von Standard-TS bitte gesondert bestellen.

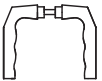
* nicht als Ht.-Drücker.

	ARTIKELBEZEICHNUNG	DR. FORM	■	BESTELL-NR.	VE
	Drückerpaar Drückerpaar	125Z 125H	8 mm 10 mm	1125/0808 2125/1008	10 Pr. 10 Pr.
	Drückerlochteil Drückerlochteil	125Z 125H	8 mm 10 mm	1125/0809 2125/1009	10 St. 10 St.

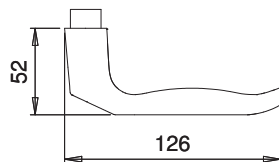



F1	F2
F3	F4

INFOthek



Zt-Drückerpaare TS 35-45 mm
Ht-Drückerpaare TS 65-75 mm.

Abweichungen von Standard-TS bitte gesondert bestellen.

	ARTIKELBEZEICHNUNG	DR. FORM	■	BESTELL-NR.	VE
	Drückerpaar Drückerpaar	137Z 137H	8 mm 10 mm	1137/0808 2137/1008	10 Pr. 10 Pr.
	Drückerlochteil Drückerlochteil	137Z 137H	8 mm 10 mm	1137/0809 2137/1009	10 St. 10 St.



Zur Unterscheidung von Premiumrosetten und Standardrosetten ist der Blick auf die Technik hinter der Rosettenkappe notwendig.

Vor allem in der Kombination mit den verschiedenen Knöpfen bzw. Griffen sind die übereinstimmenden Systeme von elementarer Bedeutung.

Bitte beachten Sie die nachstehend aufgeführten Unterscheidungsmerkmale.



PREMIUMROSETTEN-PAARE	STANDARDROSETTEN-PAARE
Unterkonstruktion: Stahl/Kunststoff	Unterkonstruktion: Kunststoff
Stütznocken Ø 8 mm	Stütznocken
Verschraubung M5	Verschraubung M4
PREMIUM-INNENROSETTE	STANDARD-INNENROSETTE
Unterkonstruktion: Stahl/Kunststoff	Unterkonstruktion Kunststoff
Durchgehende Stahlnocken Ø 8 mm	Stütznocken
Verschraubung M5	Verschraubung M4
EINSATZMÖGLICHKEITEN	EINSATZMÖGLICHKEITEN
z.B. Knopf-/Griff-Kombinationen	z.B. Alu-Wohnraum-Garnituren

7.1 PREMIUMROSETTEN

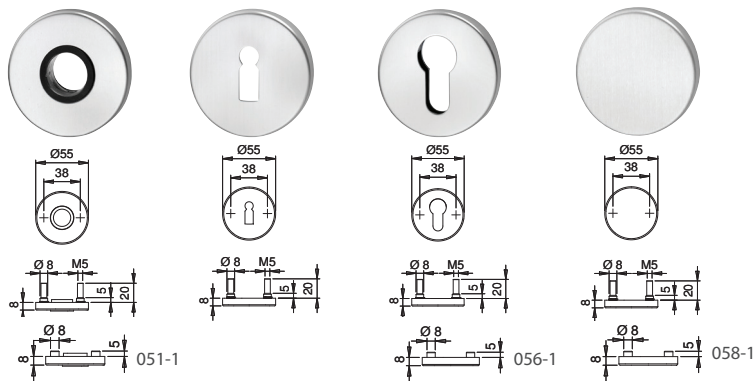

F1	EST

INFOthek



Lieferung Rosettenpaare
incl. Senkkopfschrauben
5x50 mm für TS 38-58 mm.
Einzelrosetten ohne Zubehör.

Abweichungen von Standard-
TS bitte die entsprechenden
Schrauben gesondert bestellen.
S. Zubehör ab Seite 276.

		ARTIKELBEZEICHNUNG		FORM		LOCHUNG	BESTELL- NR.	VE
		Drückerrosettenpaar Drückerrossette innen		051 051-1			1051/0000 1051/1000	5 Pr. 10 St.
		Schlüsselrosettenpaar		055		BB	1055/0000	5 Pr.
		Schlüsselrosettenpaar Schlüsselrossette innen		056 056-1		PZ PZ	1056/0000 1056/1000	5 Pr. 10 St.
		Blindrosettenpaar Blindrossette innen		058 058-1		blind blind	1058/0000 1058/1000	5 Pr. 10 St.

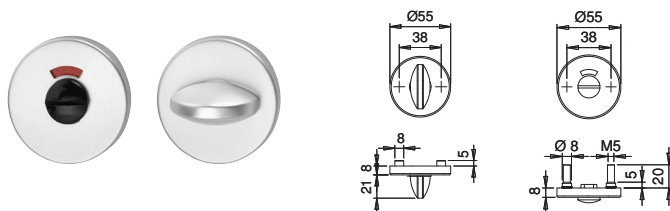

F1	EST

INFOthek



Lieferung Rosettenpaare
incl. Senkkopfschrauben
5x50 mm für TS 38-58 mm.
Einzelrosetten ohne Zubehör.

Abweichungen von Standard-
TS bitte die entsprechenden
Schrauben gesondert bestellen.
S. Zubehör ab Seite 276.

		ARTIKELBEZEICHNUNG		FORM		LOCHUNG	BESTELL- NR.	VE
		Rosettenpaar		057		WC	1057/7875	5 Pr.

7.1 STANDARDROSETTEN

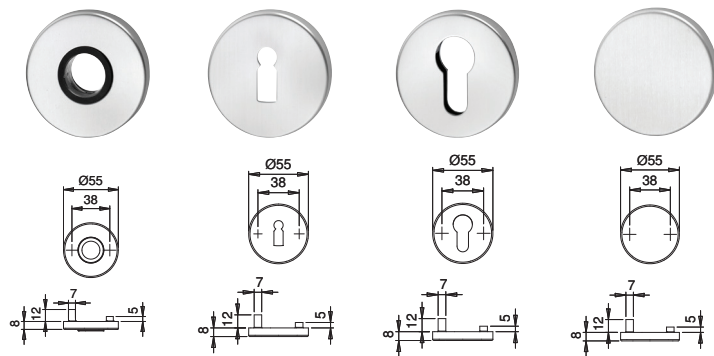

F1	F2
F3*	F4*
F9*	EST

INFOthek



Lieferung Rosettenpaare incl. Holzschrauben 4x45 mm für TS 35-45 mm.
Einzelrosetten ohne Zubehör. Abweichungen von Standard-TS bitte die entsprechenden Schrauben gesondert bestellen. S. Zubehör ab Seite 276.
*nicht 088 blind.

		ARTIKELBEZEICHNUNG		FORM		LOCHUNG	BESTELL-NR.	VE
		Drückerrosette		082			1082/0000	20 St.
		Schlüsselrosette		085		BB	1085/0000	20 St.
		Schlüsselrosette		086		PZ	1086/0000	20 St.
		Blindrosette		088		blind	1088/0000	20 St.

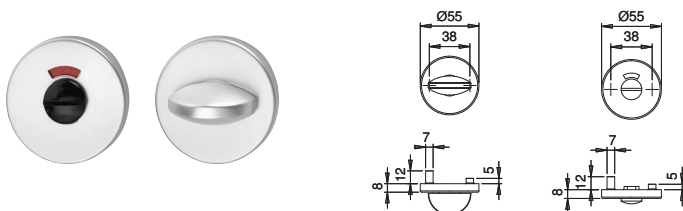

F1	F2
F3	F4
F9	

INFOthek



Lieferung Rosettenpaare incl. Holzschrauben 4x45 mm für TS 35-45 mm.
Einzelrosetten ohne Zubehör.

Abweichungen von Standard-TS bitte die entsprechenden Schrauben gesondert bestellen. S. Zubehör ab Seite 276.

		ARTIKELBEZEICHNUNG		FORM		LOCHUNG	BESTELL-NR.	VE
		Rosettenpaar		087		WC	1087/7875	10 Pr.

7.1 KNÖPFE

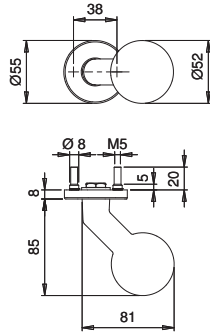

F1*	EST

INFOthek



* nicht fest-drehbar.
S. Zubehör ab Seite 276.

	ARTIKELBEZEICHNUNG	KNOPF		BESTELL-NR.	VE
	Knopf fest auf Rosette	K4		1052/4020	3 St.
	Knopf fest-drehbar auf Rosette	K4		1052/4010	3 St.

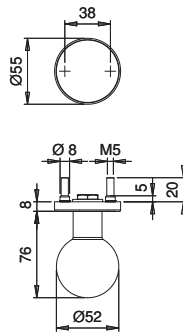

F1	EST

INFOthek



S. Zubehör ab Seite 276.

	ARTIKELBEZEICHNUNG	KNOPF		BESTELL-NR.	VE
	Knopf fest auf Rosette	K5		1052/5020	3 St.
	Knopf fest-drehbar auf Rosette	K5		1052/5010	3 St.

7.1 KNÖPFE

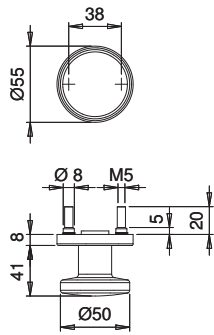

F1	EST

INFOthek



Innenrosette mit Durchgangsnocken.

S. Zubehör ab Seite 276.

	ARTIKELBEZEICHNUNG	KNOPF		BESTELL-NR.	VE
	Knopf fest auf Rosette	K7		1052/7020	3 St.
	Knopf fest-drehbar auf Rosette	K7		1052/7010	3 St.
	Knopf fest auf Rosette einschließlich Innenrosette 051	K7		2052/7020	3 St.

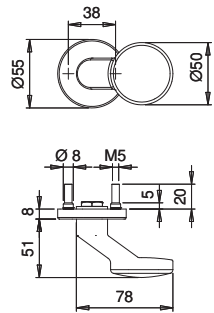

F1	EST

INFOthek



Innenrosette mit Durchgangsnocken.

S. Zubehör ab Seite 276.

	ARTIKELBEZEICHNUNG	KNOPF		BESTELL-NR.	VE
	Knopf fest auf Rosette	K16		1052/1620	3 St.

7.1 KNÖPFE

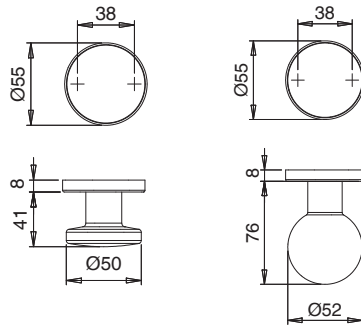
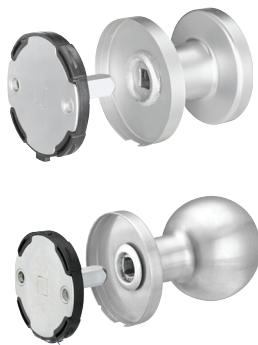

F1	EST

INFOthek



S. Zubehör ab Seite 276.

	ARTIKELBEZEICHNUNG	KNOPF		BESTELL-NR.	VE
	Knopf fest auf Rosette zur einseitigen Verschraubung	K7		1050/7020	3 St.
	Knopf fest auf Rosette zur einseitigen Verschraubung	K5		1050/5020	3 St.

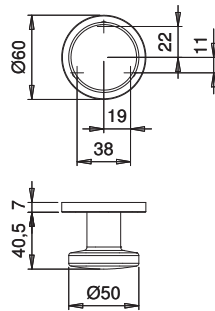

F1	

INFOthek



Sichtbare Verschraubung.

S. Zubehör ab Seite 276.

	ARTIKELBEZEICHNUNG	KNOPF		BESTELL-NR.	VE
	Knopf fest auf Rosette mit sichtbarer Verschraubung	K7		1080/7020	10 St.

7.1 KNOPFDRÜCKER

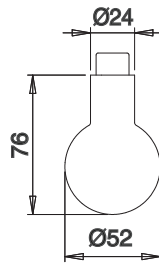
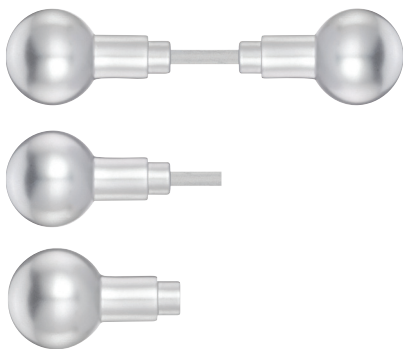

F1	F2
EST	

INFOthek



Knopfdrückerpaare
TS 35-45 mm

Abweichungen von Standard-
TS bitte gesondert bestellen.

	ARTIKELBEZEICHNUNG		KNOPF	■		BESTELL- NR.	VE
	Knopfdrückerpaar		K5	8 mm		5000/0808	5 Pr.
	Knopfdrückerlochteil		K5	8 mm		5000/0809	3 St.
	Knopfdrückerstiftteil		K5	8 mm		5000/0807	5 St.

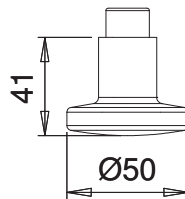
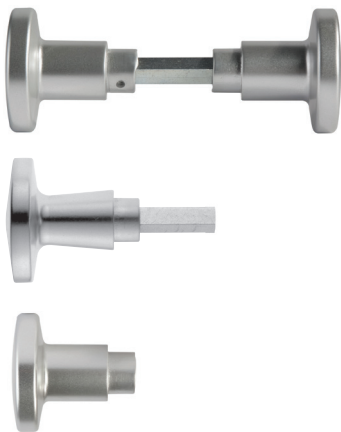

F1	F2
EST*	

INFOthek



Zt-Knopfdrückerpaare
TS 35-45 mm
Ht-Knopfdrückerpaare
TS 65-75 mm
Abweichungen von Standard-
TS bitte gesondert bestellen.

* keine Knopfdrückerstiftteile
keine 10 mm VKT

	ARTIKELBEZEICHNUNG		KNOPF	■		BESTELL- NR.	VE
	Knopfdrückerpaar Knopfdrückerpaar		K7 K7	8 mm 10 mm		7000/0808 7000/1008	5 Pr. 5 Pr.
	Knopfdrückerlochteil Knopfdrückerlochteil		K7 K7	8 mm 10 mm		7000/0809 7000/1009	10 St. 10 St.
	Knopfdrückerstiftteil Knopfdrückerstiftteil		K7 K7	8 mm 10 mm		7000/0807 7000/1007	10 St. 10 St.

7.1 RENOVIERSCHILDER



- ◆ Material: Aluminium eloxiert oder Edelstahl matt gebürstet
- ◆ Fertigung: gestanz
- ◆ WC-Schilder: mit Rot-Weiß-Scheibe
- ◆ Knopfschild: mit fest vertaumatem Knopf

RENOVIERSCHILDER ALU

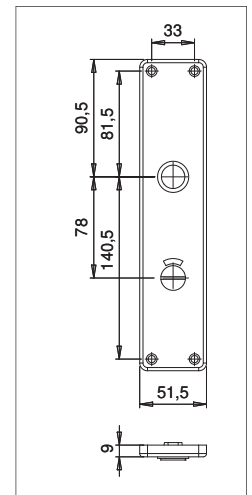
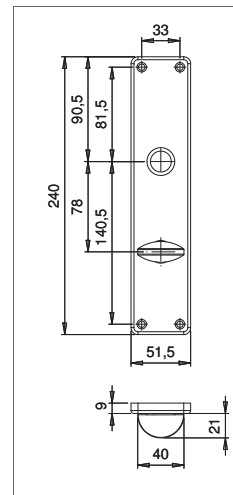
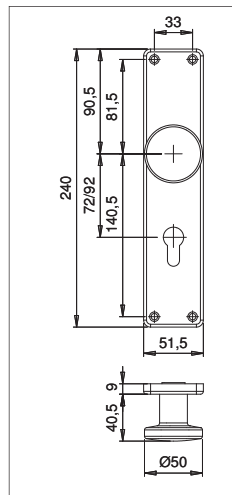
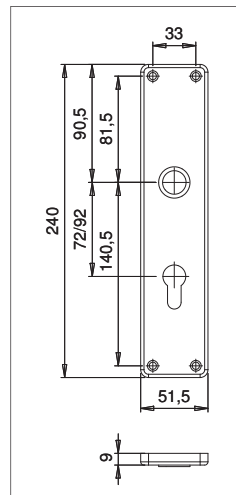
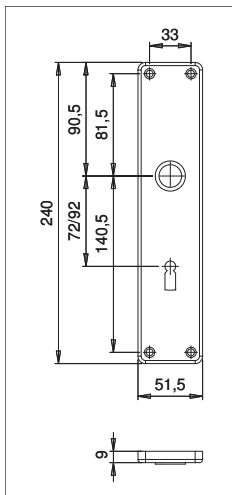

RENOVIERSCHILDER EST

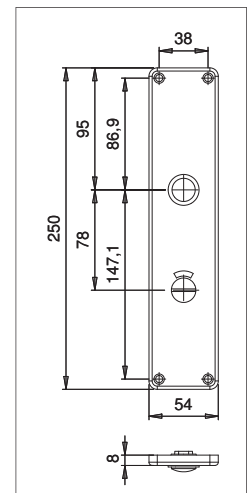
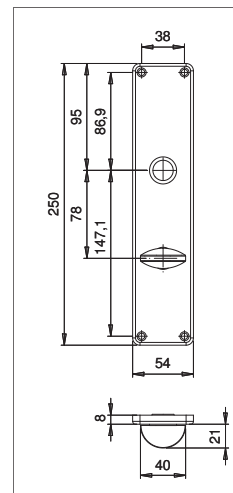
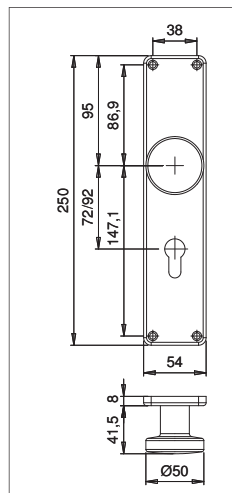
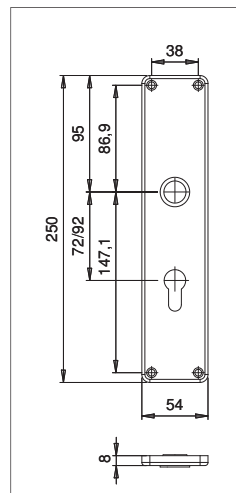
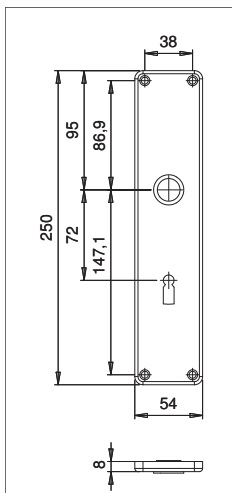

7.1 RENOVIERSCILDER



F1	F2
F4	EST*

INFOthek

Knopfschilder incl. Rollenwechselstift Typ O und Holzschrauben 3,5x17 mm, EST 4,5x20 mm. Abweichungen von Standard-TS bitte den entsprechenden Stift gesondert bestellen. * EST kein 92 mm BB. S. Zubehör ab Seite 276.



		ARTIKELBEZEICHNUNG	KNOPF	FORM		ENTF. LOCHUNG	BESTELL-NR.	VE
		Langschild Langschild		220Z 220H		72 mm BB 92 mm BB	1220/7201 2220/9201	10 St. 10 St.
		Langschild Langschild		220Z 220H		72 mm PZ 92 mm PZ	1220/7203 2220/9203	10 St. 10 St.
		Knopflangschild Knopflangschild	K7 K7	344Z 344H		72 mm PZ 92 mm PZ	1344/7203 2344/9203	1 St. 1 St.



F1	F2
F4	EST

INFOthek

Lieferung incl. Holzschrauben 3,5x17 mm, EST 4,5x20 mm. S. Zubehör ab Seite 276.



		ARTIKELBEZEICHNUNG		FORM		ENTF. LOCHUNG	BESTELL-NR.	VE
		Langschilderpaar		220		78 mm WC	1220/7875	4 Pr.

7.1 RENOVIERSCHILDER



- ◆ Material: Aluminium eloxiert oder Edelstahl matt gebürstet
- ◆ Fertigung: gestanz
- ◆ WC-Schilder: mit Rot-Weiß-Scheibe
- ◆ Knopfschild: mit fest vertaumatem Knopf

RENOVIERSCHILDER ALU

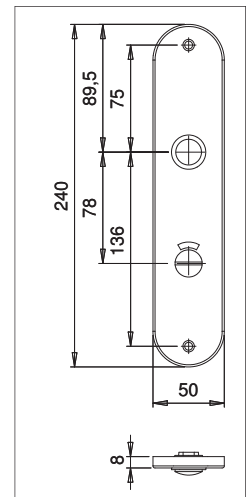
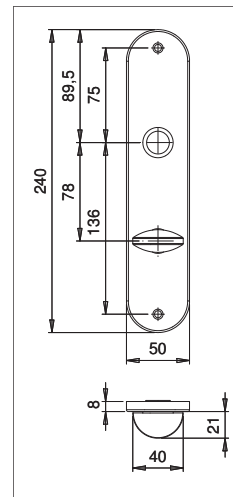
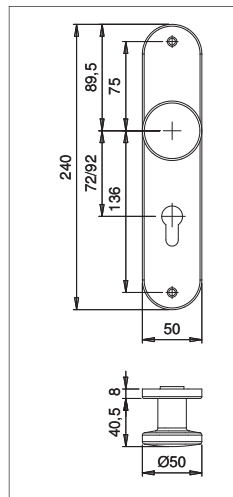
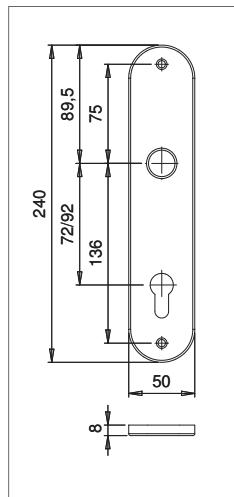
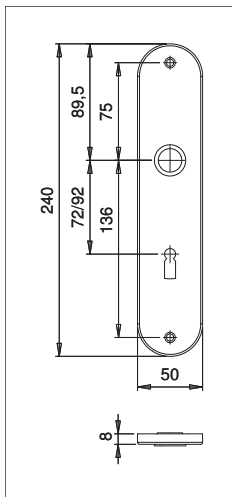

RENOVIERSCHILDER EST

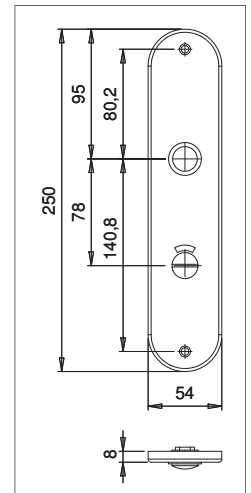
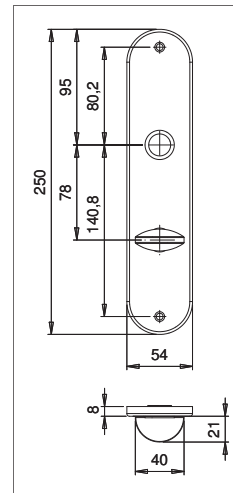
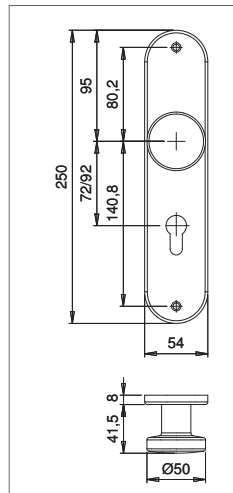
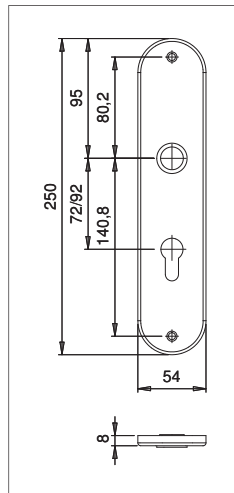
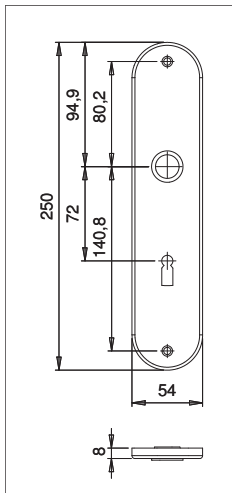

7.1 RENOVIERSCHILDER



F1	F2
EST*	

INFOthek

Knopfschilder incl. Rollenwechselstift Typ O und Holzschrauben 3,5x17 mm, EST 4,5x20 mm.
Abweichungen von Standard-TS bitte den entsprechenden Stift gesondert bestellen.
* EST kein 92 mm BB.
S. Zubehör ab Seite 276.



		ARTIKELBEZEICHNUNG	KNOPF	FORM		ENTF. LOCHUNG	BESTELL-NR.	VE
		Langschild Langschild		206Z 206H		72 mm BB 92 mm BB	1206/7201 2206/9201	10 St. 10 St.
		Langschild Langschild		206Z 206H		72 mm PZ 92 mm PZ	1206/7203 2206/9203	10 St. 10 St.
		Knopflangschild Knopflangschild	K7 K7	306Z 306H		72 mm PZ 92 mm PZ	1306/7203 2306/9203	1 St. 1 St.



F1	F2
EST	

INFOthek

Lieferung incl. Holzschrauben 3,5x17 mm, EST 4,5x20 mm.
S. Zubehör ab Seite 276.



		ARTIKELBEZEICHNUNG		FORM		ENTF. LOCHUNG	BESTELL-NR.	VE
		Langschilderpaar		206		78 mm WC	1206/7875	4 Pr.

7.1 KURZSCHILDER

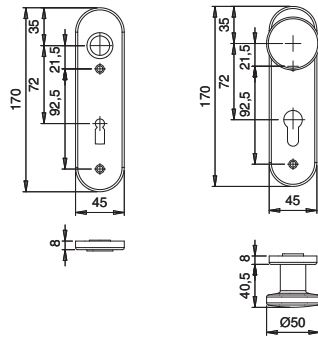

F1	

INFOthek



Knopfschilder incl. Rollenwechselstift Typ O und Holzschrauben 3,5x17 mm.

Abweichungen von Standard-TS bitte den entsprechenden Stift gesondert bestellen.

S. Zubehör ab Seite 276.

		ARTIKELBEZEICHNUNG	KNOPF	FORM		ENTF. LOCHUNG	BESTELL-NR.	VE
		Kurzschild		235Z		72 mm BB	1235/7201	20 St.
		Kurzschild		235Z		72 mm PZ	1235/7203	20 St.
		Knopfkurzschild	K7	334Z		72 mm PZ	1334/7203	1 St.

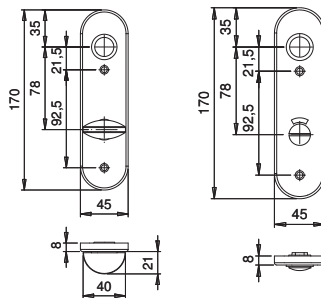

F1	

INFOthek



Lieferung incl. Holzschrauben 3,5x17 mm.

S. Zubehör ab Seite 276.

		ARTIKELBEZEICHNUNG		FORM		ENTF. LOCHUNG	BESTELL-NR.	VE
		Kurzschilderpaar		235		78 mm WC	1235/7875	5 Pr.

7.1 KURZSCHILDER

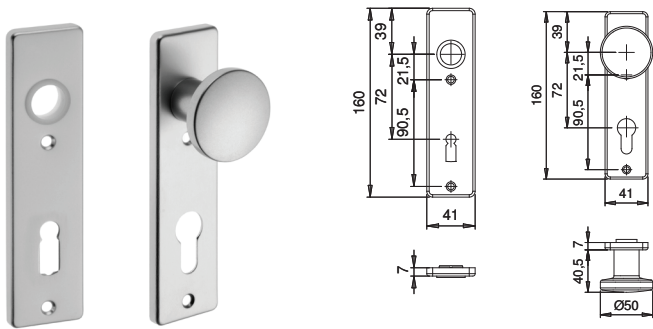

F1	F2
F3*	F4*

INFOthek



Knopfschilder incl. Rollenwechselstift Typ O und Holzschrauben 3,5x17 mm.

Abweichungen von Standard-TS bitte den entsprechenden Stift gesondert bestellen. S. Zubehör ab Seite 276.

* nicht BLIND, OSL, ODL, OSL.

		ARTIKELBEZEICHNUNG	KNOPF	FORM		ENTF. LOCHUNG	BESTELL-NR.	VE
		Kurzschild		236Z		72 mm BB	1236/7201	20 St.
		Kurzschild		236Z		72 mm PZ	1236/7203	20 St.
		Knopfcurzschild	K7	336Z		72 mm PZ	1336/7203	1 St.
		Kurzschild Kurzschild Kurzschild Knopfcurzschild		236 236 236 336		blind OSL ODL OSL	1236/0002 1236/0000 1236/0072 1336/0000	20 St. 20 St. 20 St. 1 St.

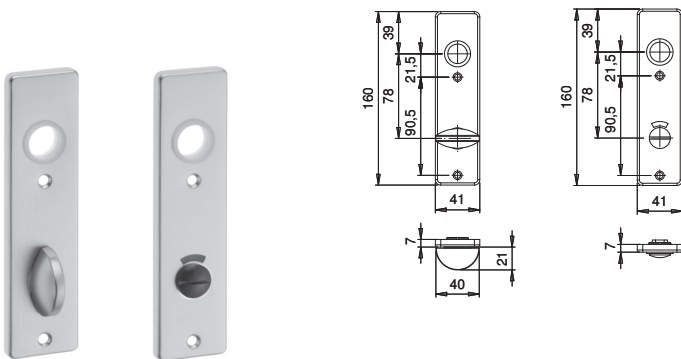

F1	F2
F3	F4

INFOthek



Lieferung incl. Holzschrauben 3,5x17 mm.

S. Zubehör ab Seite 276.

		ARTIKELBEZEICHNUNG		FORM		ENTF. LOCHUNG	BESTELL-NR.	VE
		Kurzschilderpaar		236		78 mm WC	1236/7875	5 Pr.

7.1 LANGSCHILDER

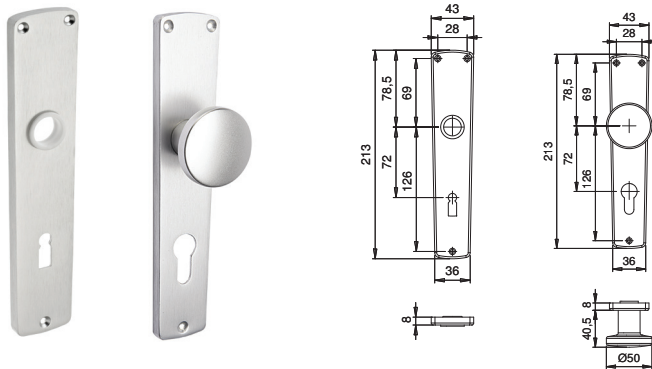

F1	F2

INFOthek



Knopfschilder incl.
Rollenwechselstift Typ O
und Holzschrauben 3,5x17 mm.

Abweichungen von Standard-
TS bitte den entsprechenden
Stift gesondert bestellen.

S. Zubehör ab Seite 276.

		ARTIKELBEZEICHNUNG	KNOPF	FORM		ENTF. LOCHUNG	BESTELL- NR.	VE
		Langschild		210Z		72 mm BB	1210/7201	10 St.
		Langschild		210Z		72 mm PZ	1210/7203	10 St.
		Knopflangschild	K7	343Z		72 mm PZ	1343/7203	1 St.

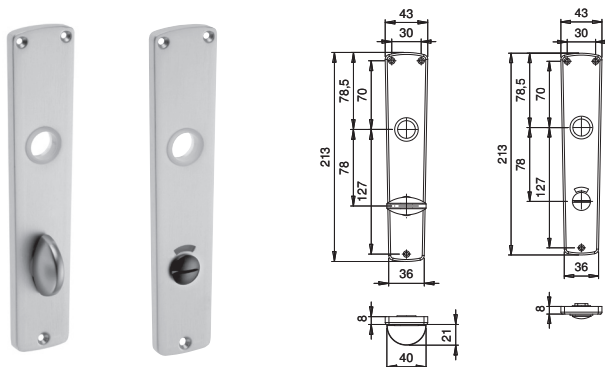

F1	F2

INFOthek



Lieferung incl.
Holzschrauben 3,5x17 mm.

S. Zubehör ab Seite 276.

		ARTIKELBEZEICHNUNG		FORM		ENTF. LOCHUNG	BESTELL- NR.	VE
		Langschilderpaar		210		78 mm WC	1210/7875	4 Pr.

7.1 LANGSCHILDER

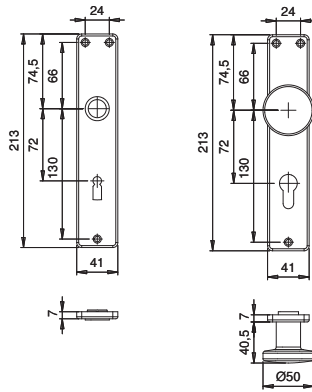

F1	F2
F3*	F4*

INFOthek



Knopfschilder incl. Rollenwechselstift Typ O und Holzschrauben 3,5x17 mm.

Abweichungen von Standard-TS bitte den entsprechenden Stift gesondert bestellen. Zubehör ab Seite 272.

* nicht BLIND, OSL, ODL, OSL.

		ARTIKELBEZEICHNUNG	KNOPF	FORM		ENTF. LOCHUNG	BESTELL-NR.	VE
		Langschild Langschild		237Z		72 mm BB	1237/7201	20 St.
		Langschild Langschild		237Z		72 mm PZ	1237/7203	20 St.
		Knopflangschild Knopflangschild	K7	337Z		72 mm PZ	1337/7203	1 St.
		Langschild Langschild Langschild		237 237 237		BLIND OSL ODL	1237/0002 1237/0000 1237/0072	20 St. 20 St. 20 St.

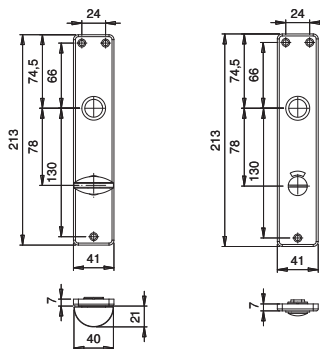

F1	F2
F3	F4

INFOthek



Lieferung incl. Holzschrauben 3,5x17 mm.

S. Zubehör ab Seite 276.

		ARTIKELBEZEICHNUNG		FORM		ENTF. LOCHUNG	BESTELL-NR.	VE
		Langschilderpaar		237		78 mm WC	1237/7875	5 Pr.

7.2 ALU-GARNITUREN (SCHRUMPFPAK)

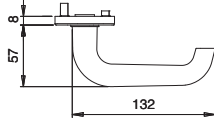
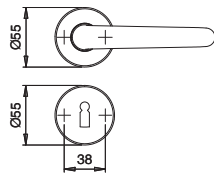

F1	

INFOthek



Aluminium-Drückergarnitur
incl. Zubehör für TS 35-45 mm,
platzsparend und
schützend eingeschweißt, für
schnellen und problemlosen
Abverkauf.

		ARTIKELBEZEICHNUNG		DR. FORM	■	ENTF. LOCHUNG	BESTELL-NR.	VE
		Rosetten-Garnitur		104Z	8 mm	BB	1706/0000	25 Grt.
		Rosetten-Garnitur		104Z	8 mm	PZ	1706/0003	25 Grt.
		Rosetten-Garnitur		104Z	8 mm	WC	1708/0000	25 Grt.

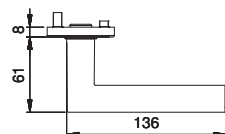
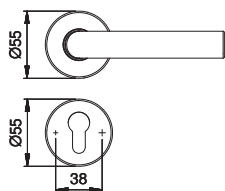

F1	

INFOthek



Aluminium-Drückergarnitur
incl. Zubehör für TS 35-45 mm,
platzsparend und
schützend eingeschweißt, für
schnellen und problemlosen
Abverkauf.

		ARTIKELBEZEICHNUNG		DR. FORM	■	ENTF. LOCHUNG	BESTELL-NR.	VE
		Rosetten-Garnitur		108Z	8 mm	BB	1761/0000	25 Grt.
		Rosetten-Garnitur		108Z	8 mm	PZ	1761/0003	25 Grt.
		Rosetten-Garnitur		108Z	8 mm	WC	1763/0000	25 Grt.

7.2 ALU-GARNITUREN (SCHRUMPFPAK)

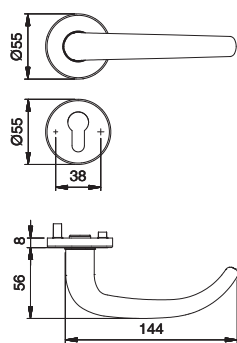







F1	

INFOthek



Aluminium-Drückergarnitur
incl. Zubehör für TS 35-45 mm,
platzsparend und
schützend eingeschweißt, für
schnellen und problemlosen
Abverkauf.

		ARTIKELBEZEICHNUNG		DR. FORM	■	ENTF. LOCHUNG	BESTELL- NR.	VE
		Rosetten-Garnitur		114Z	8 mm	BB	1724/0000	25 Grt.
		Rosetten-Garnitur		114Z	8 mm	PZ	1724/0003	25 Grt.
		Rosetten-Garnitur		114Z	8 mm	WC	1725/0000	25 Grt.

7.2 ALU-GARNITUREN (SCHRUMPFPAK)

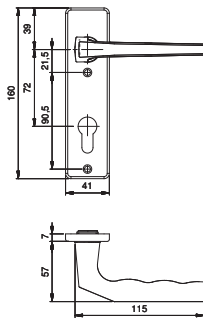

F1	F2

INFOthek



Aluminium-Drückergarnitur
incl. Zubehör für TS 35-45 mm,
platzsparend und
schützend eingeschweißt, für
schnellen und problemlosen
Abverkauf.

		ARTIKELBEZEICHNUNG	SCHILD FORM	DR. FORM	■	ENTF. LOCHUNG	BESTELL- NR.	VE
		Kurzschild-Garnitur	236Z	125Z	8 mm	72 mm BB	1700/0000	25 Grt.
		Kurzschild-Garnitur	236Z	125Z	8 mm	72 mm PZ	1700/0003	25 Grt.
		Kurzschild-Garnitur	236Z	125Z	8 mm	78 mm WC	1702/0000	25 Grt.

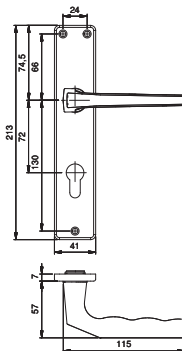

F1	F2

INFOthek



Aluminium-Drückergarnitur
incl. Zubehör für TS 35-45 mm,
platzsparend und
schützend eingeschweißt, für
schnellen und problemlosen
Abverkauf.

		ARTIKELBEZEICHNUNG	SCHILD FORM	DR. FORM	■	ENTF. LOCHUNG	BESTELL- NR.	VE
		Langschild-Garnitur	237Z	125Z	8 mm	72 mm BB	1701/0000	25 Grt.
		Langschild-Garnitur	237Z	125Z	8 mm	72 mm PZ	1701/0003	25 Grt.
		Langschild-Garnitur	237Z	125Z	8 mm	78 mm WC	1703/0000	25 Grt.

7.2 ALU-GARNITUREN (SCHRUMPPACK)

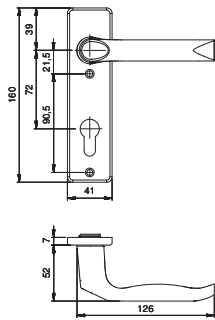

F1	F2

INFOthek



Aluminium-Drückergarnitur incl. Zubehör für TS 35-45 mm, platzsparend und schützend eingeschweißt, für schnellen und problemlosen Abverkauf.

		ARTIKELBEZEICHNUNG	SCHILD FORM	DR. FORM	■	ENTF. LOCHUNG	BESTELL-NR.	VE
		Kurzschild-Garnitur	236Z	137Z	8 mm	72 mm BB	1742/0000	25 Grt.
		Kurzschild-Garnitur	236Z	137Z	8 mm	72 mm PZ	1742/0003	25 Grt.
		Kurzschild-Garnitur	236Z	137Z	8 mm	78 mm WC	1743/0000	25 Grt.

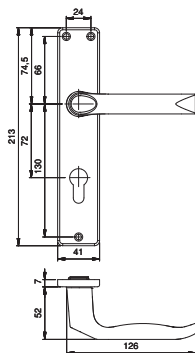

F1	F2

INFOthek



Aluminium-Drückergarnitur incl. Zubehör für TS 35-45 mm, platzsparend und schützend eingeschweißt, für schnellen und problemlosen Abverkauf.

		ARTIKELBEZEICHNUNG	SCHILD FORM	DR. FORM	■	ENTF. LOCHUNG	BESTELL-NR.	VE
		Langschild-Garnitur	237Z	137Z	8 mm	72 mm BB	1773/0000	25 Grt.
		Langschild-Garnitur	237Z	137Z	8 mm	72 mm PZ	1773/0003	25 Grt.
		Langschild-Garnitur	237Z	137Z	8 mm	78 mm WC	1771/0000	25 Grt.

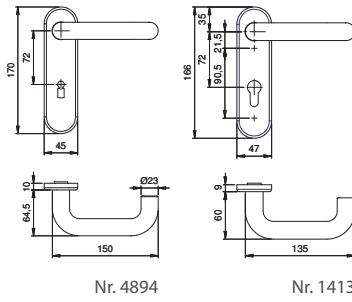





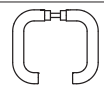

F12*	F14

INFOthek 

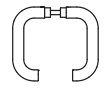
Lieferung incl.
Befestigungszubehör für
TS 38-42 mm, FS 40-66 mm.

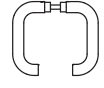
* nicht FS

		ARTIKELBEZEICHNUNG	DR.-Ø	■	LOCHUNG	F	BESTELL-NR.	VE
		Kurzschild-Garnitur	23 mm	8 mm	BB		4894/0000	1 Grt.
		Kurzschild-Garnitur FS-Kurzschild-Garnitur	23 mm 23 mm	8 mm 9 mm	PZ PZ	x	4895/0000 1413/0000	1 Grt. 1 Grt.
		Kurzschild-Garnitur	23 mm	8 mm	WC		4896/0000	1 Grt.

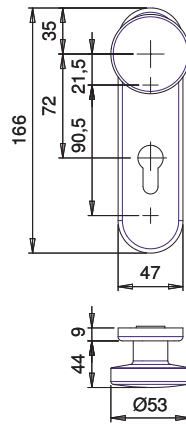

F14	

INFOthek 

Lieferung incl.
Befestigungszubehör für
TS 40-66 mm.

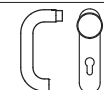
		ARTIKELBEZEICHNUNG	DR.-Ø	■	LOCHUNG	F	BESTELL-NR.	VE
		FS-Kurzschild-Wechsel-Garnitur mit Knopf	23 mm	9 mm	PZ	x	1414/0000	1 Grt.

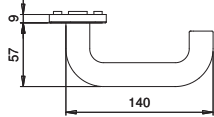
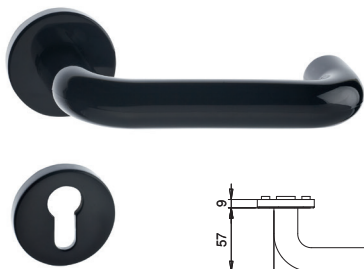

Nr. 1415

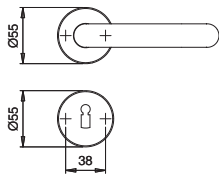

Nr. 4850

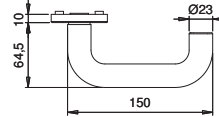
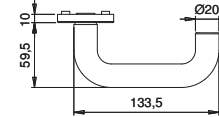







Nr. 4890

F12*	F14

INFOthek 

Lieferung incl.
Befestigungszubehör für
TS 38-42 mm, FS 40-66 mm.

* nicht FS

		ARTIKELBEZEICHNUNG	DR.-Ø	■	LOCHUNG	F	BESTELL-NR.	VE
		Rosetten-Garnitur Rosetten-Garnitur	20 mm 23 mm	8 mm 8 mm	BB BB		4850/0000 4890/0000	1 Grt. 1 Grt.
		Rosetten-Garnitur Rosetten-Garnitur FS-Rosetten-Garnitur	20 mm 23 mm 23 mm	8 mm 8 mm 9 mm	PZ PZ PZ	x	4862/0000 4891/0000 1415/0000	1 Grt. 1 Grt. 1 Grt.
		Rosetten-Garnitur Rosetten-Garnitur	20 mm 23 mm	8 mm 8 mm	WC WC		4852/0000 4892/0000	1 Grt. 1 Grt.

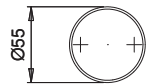

F14	

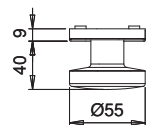
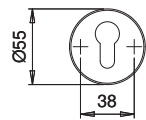

INFOthek 

Lieferung incl.
Befestigungszubehör für
TS 40-66 mm.

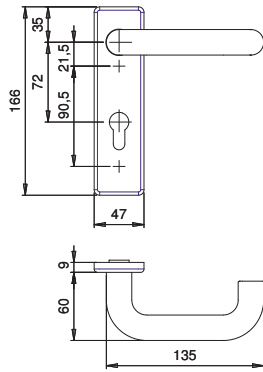

		ARTIKELBEZEICHNUNG	DR.-Ø	■	LOCHUNG	F	BESTELL-NR.	VE
		FS-Rosetten-Wechsel-Garnitur mit Knopf	23 mm	9 mm	PZ	x	1416/0000	1 Grt.



F14	

INFOthek 

Lieferung incl.
Befestigungszubehör für
TS 40-66 mm.

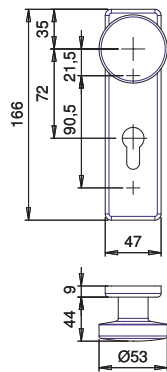

		ARTIKELBEZEICHNUNG	DR.-Ø	■	ENTF. LOCHUNG	F	BESTELL-NR.	VE
		FS-Kurzschild-Garnitur	23 mm	9 mm	72 mm PZ	x	1428/0000	1 Grt.



F14	

INFOthek 

Lieferung incl.
Befestigungszubehör für
TS 40-66 mm.

		ARTIKELBEZEICHNUNG	DR.-Ø	■	ENTF. LOCHUNG	F	BESTELL-NR.	VE
		FS-Kurzschild-Wechsel-Garnitur mit Knopf	23 mm	9 mm	72 mm PZ	x	1429/0000	1 Grt.

edi | Alles aus einer Hand



Erich Dieckmann GmbH
Grüner Talstraße 18 - 22
58644 Iserlohn

Tel : +49 02371 956-0
Fax: +49 02371 956-120
Mail: info@dieckmann.com