

**Nr.**

3. Auflage

... der greifbare Unterschied

250

72/92

21,5

95

75,5

**Objektbeschlage**

---

# OBJEKTBESCHLÄGE





---

<b>6</b>	<b>BESCHLÄGE FÜR OBJEKTÜREN</b>	<b>Seiten 197 - 224</b>
<b>6.1</b>	Innentür-Garnituren Klasse 4 (incl. Feuerschutz- und Fluchttür)	204 - 219
<b>6.2</b>	Montagesets Objekt-Garnituren	220
<b>6.3</b>	Innentür-Garnituren Klasse 3	221 - 224

6.1 SERIE RIVA



DIN EN 1906 KLASSE 4

DIN EN 179

DIN 18273 **F**

Seiten 204 - 207

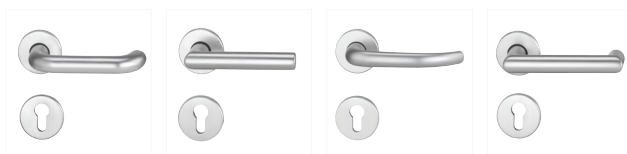

6.1 SERIE RIVA



DIN EN 1906 KLASSE 4

DIN EN 179

DIN 18273 **F**

Seiten 208 - 210



6.1 SERIE TARGA/K

DIN EN 1906 KLASSE 4

DIN EN 179

DIN 18273 **F**

Seiten 212 - 215



6.1 SERIE TARGA/L

DIN EN 1906 KLASSE 4

DIN EN 179

DIN 18273 **F**

Seiten 216 - 219



### 6.3 SERIE INDIA

DIN EN 1906 KLASSE 3

Seiten 222 - 225

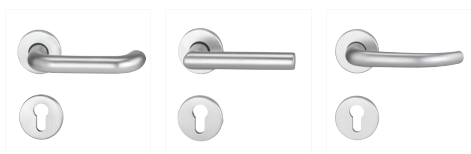



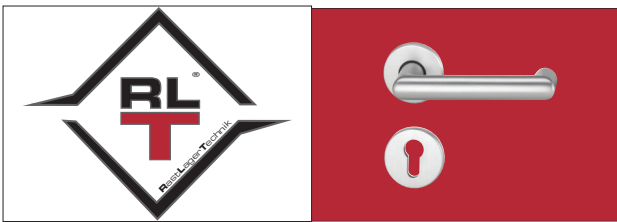

Eine innovative Beschlagtechnik, die die Bereiche Objektbeschläge und Feuerschutzbeschläge aus dem Hause dieckmann ganz neu definiert.



Einbau der Rosetten am Türblatt.

Die voneinander unabhängige Montage der Rosetten und Drückerlochteile erlaubt eine komfortable Handhabung beim Einbau der Beschläge, **unkompliziert**, **mühelos** und **blitzschnell** durch die geschützte Rasttechnik.



Der zeitliche Aufwand für die Montage (und Demontage) der Garnituren wird auf ein Minimum reduziert und bedarf nur weniger Handgriffe:



Vierkant in die Schlossnuss schieben.

Drücker auf den Vierkant stecken und einrasten.

Dennoch erfüllt der Beschlag die Anforderungen der **DIN 1906** und, wenn gefordert, auch der **DIN 18273** und **DIN EN 179**, denn Rosette und Türdrücker gehen eine fest-drehbare Verbindung ein, sobald der Drücker in der Rosette eingearastet ist.







Verriegelungsposition des Schließers beachten. Madenschraube fest anziehen. Fertig.

Eventuelle einfache Demontage mit gängigem Werkzeug.

Die ungehinderte Verschraubung der Grundrosetten ist selbst für große Türstärken gewährleistet (auch bei Gehrungsdrückern).



					Klassifizierungsschlüssel								
DIN EN 1906			ALU	EST	→	4	7	-	0	1	3	O	U
DIN EN 1906	DIN 18273 	DIN EN 179 	ALU		→	4	7	-	D	1	3	O	U
DIN EN 1906	DIN 18273 	DIN EN 179 	EST		→	4	7	-	C	1	3	O	U



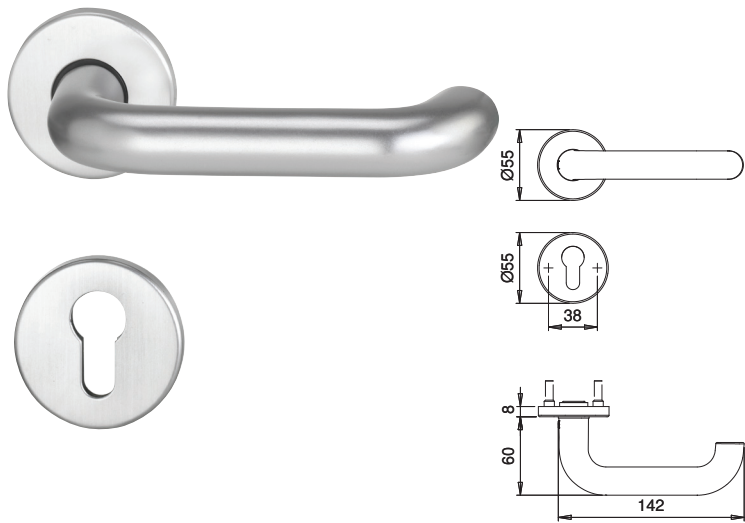

F1	EST

**INFOthek**



Lieferung incl. Befestigungszubehör für TS 38-58 mm (WC TS 38-48 mm).

Abweichungen von Standard-TS bitte gesondert bestellen.

Standard-WE-Grt. mit K7, mögliche Varianten: K4, K5, K16.

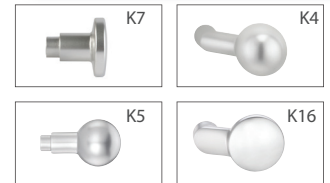

- ◆ Material: Aluminium eloxiert oder Edelstahl matt gebürstet
- ◆ Grundkonstruktion: Stahl / Kunststoff mit selbsttätiger Verbindungsmechanik bzw. Entriegelung
- ◆ Rosetten-Ø: 55 mm
- ◆ Eloxalfarbe: F1 silberfarbig
- ◆ Drücker-Lagerung: fest-drehbar
- ◆ Stütznocken: Stahl Ø 8 mm
- ◆ Verschraubung: M5, verdeckt
- ◆ Einbauwesen: präzise Schnellmontage durch Steckverbindung
- ◆ Fluchttür-Garnitur: geprüft nach **DIN EN 179** in Kombination mit zugelassenen Schlössern (Info.S. 21)

		ARTIKELBEZEICHNUNG	DR. FORM	■	LOCHUNG			BESTELL-NR.	VE
		Rosetten-Garnitur	103	8 mm	BB			5903/8501	1 Grt.
		Rosetten-Garnitur	103	8 mm	PZ			5903/8603	1 Grt.
		Rosetten-Garnitur	103	8 mm	WC			5903/8704	1 Grt.
		Rosetten-Wechselgarnitur mit Knopf K7	103	8 mm	PZ			5903/0786	1 Grt.
		FS-Ros.-Wechselgarnitur mit Knopf K7	103	9 mm	PZ	x	x	5403/0786	1 Grt.
		FS-Rosetten-Garnitur	103	9 mm	PZ	x		5403/8603	1 Grt.
		FS-Rosetten-Fluchttür-Garnitur	103	9 mm	PZ	x	x	5403/6060	1 Grt.
		FS-Standflügel-Garnitur einseitig mit Blindrosette ohne Schlüsselrosetten	103	9 mm		x	x	5403/0000	1 Grt.

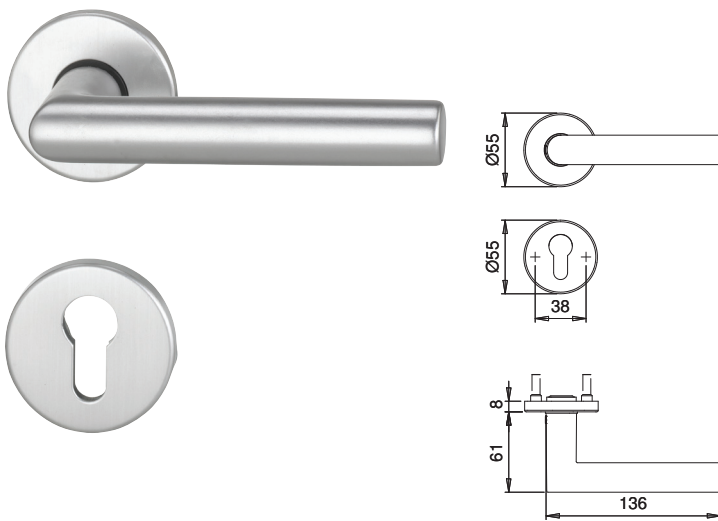

F1	EST

**INFOthek**



Lieferung incl. Befestigungszubehör für TS 38-58 mm (WC TS 38-48 mm).

Abweichungen von Standard-TS bitte gesondert bestellen.

Standard-WE-Grt. mit K7, mögliche Varianten K4, K5, K16.

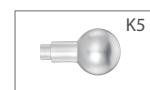

- ◆ Material: Aluminium eloxiert oder Edelstahl matt gebürstet
- ◆ Grundkonstruktion: Stahl / Kunststoff mit selbsttätiger Verbindungsmechanik bzw. Entriegelung
- ◆ Rosetten-Ø: 55 mm
- ◆ Eloxalfarbe: F1 silberfarbig
- ◆ Drücker-Lagerung: fest-drehbar
- ◆ Stütznocken: Stahl Ø 8 mm
- ◆ Verschraubung: M5, verdeckt
- ◆ Einbauweisen: präzise Schnellmontage durch Steckverbindung



		ARTIKELBEZEICHNUNG	DR. FORM	■	LOCHUNG	F	BESTELL-NR.	VE
		Rosetten-Garnitur	108	8 mm	BB		5908/8501	1 Grt.
		Rosetten-Garnitur	108	8 mm	PZ		5908/8603	1 Grt.
		Rosetten-Garnitur	108	8 mm	WC		5908/8704	1 Grt.
		Rosetten-Wechselgarnitur mit Knopf K7	108	8 mm	PZ		5908/0786	1 Grt.
		FS-Ros.-Wechselgarnitur mit Knopf K7	108	9 mm	PZ	x	5408/0786	1 Grt.
		FS-Rosetten-Garnitur	108	9 mm	PZ	x	5408/8603	1 Grt.
		FS-Standflügel-Garnitur einseitig mit Blindrosette ohne Schlüsselrosetten	108	9 mm		x	5408/0000	1 Grt.

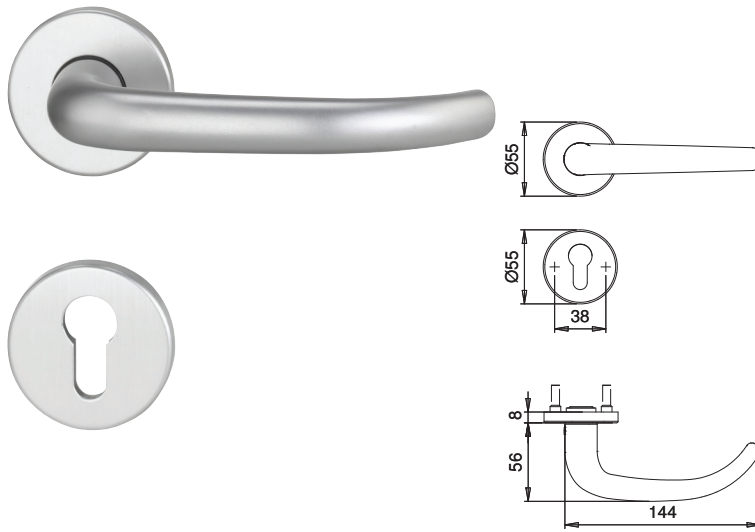

F1	EST

**INFOthek**



Lieferung incl. Befestigungszubehör für TS 38-58 mm (WC TS 38-48 mm).

Abweichungen von Standard-TS bitte gesondert bestellen.

Standard-WE-Grt. mit K7, mögliche Varianten: K4, K5, K16.

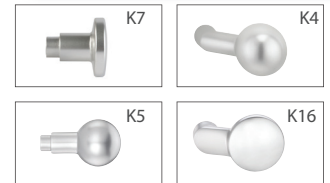

- ◆ Material: Aluminium eloxiert oder Edelstahl matt gebürstet
- ◆ Grundkonstruktion: Stahl / Kunststoff mit selbsttätiger Verbindungsmechanik bzw. Entriegelung
- ◆ Rosetten-Ø: 55 mm
- ◆ Eloxalfarbe: F1 silberfarbig
- ◆ Drücker-Lagerung: fest-drehbar
- ◆ Stütznocken: Stahl Ø 8 mm
- ◆ Verschraubung: M5, verdeckt
- ◆ Einbauwesen: präzise Schnellmontage durch Steckverbindung
- ◆ Fluchttür-Garnitur: geprüft nach **DIN EN 179** in Kombination mit zugelassenen Schlössern (Info.S.21)

		ARTIKELBEZEICHNUNG	FORM	■	LOCHUNG			BESTELL-NR.	VE
		Rosetten-Garnitur	114	8 mm	BB			5914/8501	1 Grt.
		Rosetten-Garnitur	114	8 mm	PZ			5914/8603	1 Grt.
		Rosetten-Garnitur	114	8 mm	WC			5914/8704	1 Grt.
		Rosetten-Wechselgarnitur mit Knopf K7	114	8 mm	PZ			5914/0786	1 Grt.
		FS-Ros.-Wechselgarnitur mit Knopf K7	114	9 mm	PZ	x	x	5414/0786	1 Grt.
		FS-Rosetten-Garnitur	114	9 mm	PZ	x		5414/8603	1 Grt.
		FS-Rosetten-Fluchttür-Garnitur	114	9 mm	PZ	x	x	5414/6060	1 Grt.
		FS-Standflügel-Garnitur einseitig mit Blindrosette ohne Schlüsselrosetten	114	9 mm		x	x	5414/0000	1 Grt.

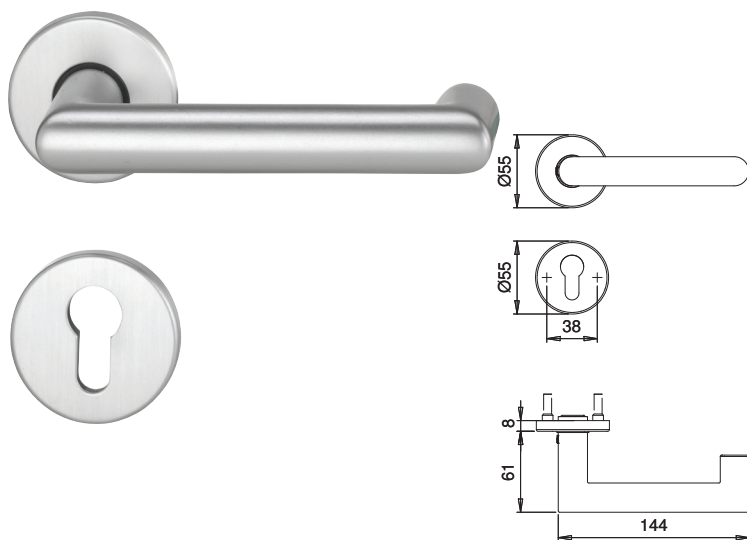

F1	EST

**INFOthek** 

Lieferung incl. Befestigungszubehör für TS 38-58 mm (WC TS 38-48 mm).

Abweichungen von Standard-TS bitte gesondert bestellen.

Standard-WE-Gr. mit K7, mögliche Varianten K4, K5, K16.

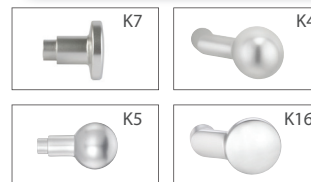

- ◆ Material: Aluminium eloxiert oder Edelstahl matt gebürstet
- ◆ Grundkonstruktion: Stahl / Kunststoff mit selbsttätiger Verbindungsmechanik bzw. Entriegelung
- ◆ Rosetten-Ø: 55 mm
- ◆ Eloxalfarbe: F1 silberfarbig
- ◆ Drücker-Lagerung: fest-drehbar
- ◆ Stütznocken: Stahl Ø 8 mm
- ◆ Verschraubung: M5, verdeckt
- ◆ Einbauwesen: präzise Schnellmontage durch Steckverbindung
- ◆ Fluchttür-Garnitur: geprüft nach DIN EN 179 in Kombination mit zugelassenen Schlössern (Info.S.21)

		ARTIKELBEZEICHNUNG	FORM	■	LOCHUNG	<b>F</b>		BESTELL-NR.	VE
		Rosetten-Garnitur	136	8 mm	BB			5936/8501	1 Grt.
		Rosetten-Garnitur	136	8 mm	PZ			5936/8603	1 Grt.
		Rosetten-Garnitur	136	8 mm	WC			5936/8704	1 Grt.
		Rosetten-Wechselgarnitur mit Knopf K7	136	8 mm	PZ			5936/0786	1 Grt.
		FS-Ros.-Wechselgarnitur mit Knopf K7	136	9 mm	PZ	x	x	5436/0786	1 Grt.
		FS-Rosetten-Garnitur	136	9 mm	PZ	x		5436/8603	1 Grt.
		FS-Rosetten-Fluchttür-Garnitur	136	9 mm	PZ	x	x	5436/6060	1 Grt.
		FS-Standflügel-Garnitur einseitig mit Blindrosette ohne Schlüsselrosetten	136	9 mm		x	x	5436/0000	1 Grt.



F1	EST

**INFOthek** 

Lieferung incl.  
Befestigungszubehör für  
TS 38-58 mm (WC TS 38-48 mm).

- ◆ Material: Aluminium eloxiert oder Edelstahl matt gebürstet
- ◆ Grundkonstruktion: Stahl/Kunststoff
- ◆ Rosetten-Ø: 55 mm
- ◆ Eloxalfarbe: F1 silberfarbig
- ◆ Stütznocken: Stahl Ø 8 mm zur gegenseitigen Verschraubung
- ◆ Verschraubung: M5, verdeckt
- ◆ Innenrosette: mit durchgehenden Nocken. Verwendbar zur gegenseitigen Verschraubung mit Knöpfen auf Rosette (s. S. 208).

Die Zertifizierungen bleiben auch bei einer Konfiguration aus Einzelteilen der Serie RIVA erhalten, dies gilt jedoch nur in Kombination mit edi-Montagezubehör. Darüber hinaus ist auf eine normenkonforme Etikettierung zu achten.

	ARTIKELBEZEICHNUNG	DR. FORM	LOCHUNG	BESTELL-NR.	VE
	Drückerrosettenpaar 	052		1052/0000	5 Pr.
	Drückerrosette innen	052-1		1052/1000	10 St.
	Schlüsselrosettenpaar	055	BB	1055/0000	5 Pr.
	Schlüsselrosettenpaar	056	PZ	1056/0000	5 Pr.
	Blindrosettenpaar	058	blind	1058/0000	5 Pr.
	Blindrosette, außen	058-2	blind	1058/2000	10 St.
	Rosettenpaar	057	WC	1057/7875	5 Pr.

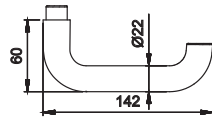







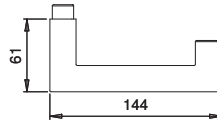
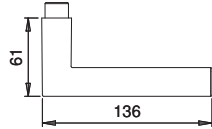
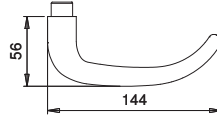



F1	EST

**INFOthek**

Drücker mit Nut für RL-Technik.

	ARTIKELBEZEICHNUNG	DR. FORM	■			BESTELL-NR.	VE
	Drückerlochteil		103Z	8 mm		5903/0809	4 St.
	FS-Drückerlochteil		103FS	9 mm	x	5403/0909	4 St.
	Drückerlochteil		108Z	8 mm		5908/0809	4 St.
	FS-Drückerlochteil		108FS	9 mm	x	5408/0909	4 St.
	Drückerlochteil		114Z	8 mm		5914/0809	4 St.
	FS-Drückerlochteil		114FS	9 mm	x	5414/0909	4 St.
	Drückerlochteil		136Z	8 mm		5936/0809	4 St.
	FS-Drückerlochteil		136FS	9 mm	x	5436/0909	4 St.



F1*	EST

**INFOthek** 

Lieferung ohne Befestigungszubehör.

\* K4 fest-drehbar nur EST.

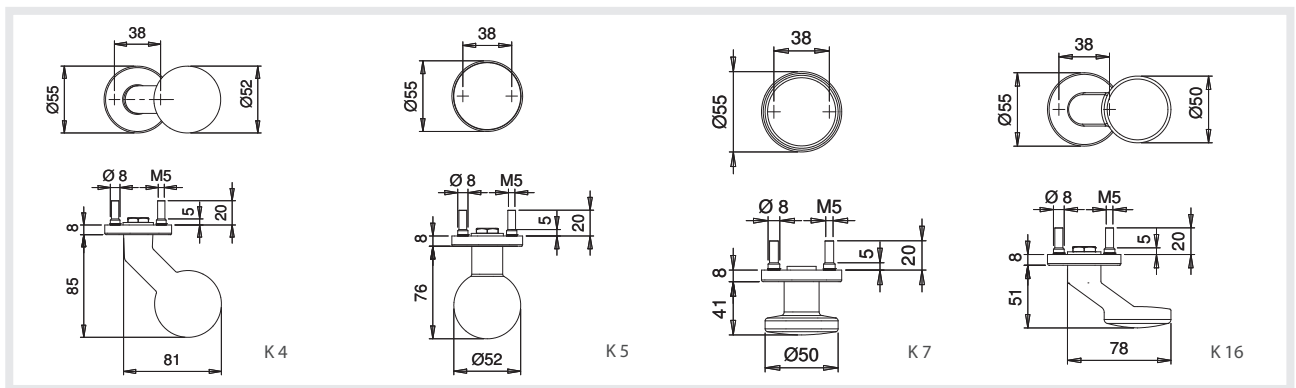

	ARTIKELBEZEICHNUNG	FORM	■			BESTELL-NR.	VE
	Knopf fest auf Rosette	K 4	M12			1052/4020	3 St.
	Knopf fest-drehbar auf Rosette	K 4	8 mm			1052/4010	3 St.
	Knopf fest auf Rosette	K 5	M12			1052/5020	3 St.
	Knopf fest-drehbar auf Rosette	K 5	8 mm			1052/5010	3 St.
	Knopf fest auf Rosette	K 7	M12			1052/7020	3 St.
	Knopf fest-drehbar auf Rosette	K 7	8 mm			1052/7010	3 St.
	Knopf fest auf Rosette	K 16	M12			1052/1620	3 St.



Serie TARGA berücksichtigt mit exzellenter Schildbreite die besonderen Gewichte und Dimensionen von Objekttüren.

Qualitätsorientierung ist unser Anspruch







Die Garnituren überzeugen mit komfortablen Proportionen und empfehlen sich damit auch als Renovierbeschläge, sowohl für den **Objektbedarf** als auch für den privaten Wohnbereich.

Ohne sichtbare Verschraubung werden alte Schildabdrücke verdeckt. Eine elegante Lösung beim Austausch **alt gegen neu**.



Klares, schnörkelloses Design der Modellauswahl ist ein Gestaltungselement für den Wohn- und Einrichtungsbereich, das unverwechselbare und wertige Akzente setzt und bei dem Individualität und Stil zum Ausdruck kommen.

Diese Konzentration auf das Wesentliche wird zur einfachen und sicheren Orientierung einer optischen Linie in allen Anwendungsbereichen, auch im **gehobenen Objekt**.

					Klassifizierungsschlüssel								
DIN EN 1906			ALU	EST	→	4	7	-	0	1	3	O	U
DIN EN 1906	DIN 18273 	DIN EN 179 	ALU		→	4	7	-	D	1	3	O	U
DIN EN 1906	DIN 18273 	DIN EN 179 	EST		→	4	7	-	C	1	3	O	U



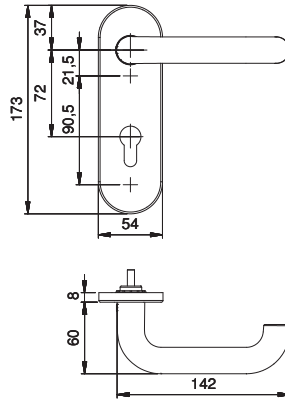

F1	EST

**INFOthek** 



Lieferung incl. Befestigungszubehör für TS 38-58 mm (WC TS 38-48 mm).

Abweichungen von Standard-TS bitte gesondert bestellen.

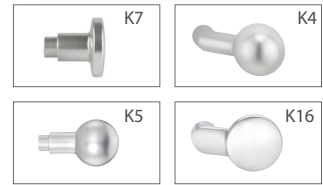
Standard-WE-Grt. mit K7, mögliche Varianten: K4, K5, K16.

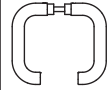

- ◆ Material: Aluminium eloxiert oder Edelstahl matt gebürstet
- ◆ Grundkonstruktion: Stahl
- ◆ Eloxalfarbe: F1 silberfarbig
- ◆ Drücker-Lagerung: fest-drehbar
- ◆ Stütznocken: Stahl Ø 8 mm
- ◆ Verschraubung: M5, verdeckt
- ◆ Fluchttür-Garnitur: geprüft nach **DIN EN 179** in Kombination mit zugelassenen Schlössern (Info.S.21)

		ARTIKELBEZEICHNUNG	DR. FORM	■	ENTF. LOCHUNG			BESTELL-NR.	VE
		Kurzschild-Garnitur	103	8 mm	72 mm BB			5603/7201	1 Grt.
		Kurzschild-Garnitur	103	8 mm	72 mm PZ			5603/7203	1 Grt.
		Kurzschild-Garnitur	103	8 mm	78 mm WC			5603/7875	1 Grt.
		Kurzschild-Wechselgarnitur mit Knopf K7	103	8 mm	72 mm PZ			5603/0772	1 Grt.
		FS-Kurzschild-Wechselgarnitur mit Knopf K7	103	9 mm	72 mm PZ	x	x	5203/0772	1 Grt.
		FS-Kurzschild-Garnitur	103	9 mm	72 mm PZ	x		5203/7203	1 Grt.
		FS-Kurzschild-Fluchttür-Garnitur	103	9 mm	72 mm PZ	x	x	5203/6060	1 Grt.
		FS-Standflügel-Garnitur einseitig mit Blindschild	103	9 mm	OSL/blind	x	x	5203/0000	1 Grt.

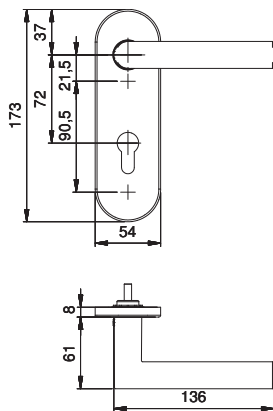

F1	EST

**INFOthek**



Lieferung incl. Befestigungszubehör für TS 38-58 mm (WC TS 38-48 mm).

Abweichungen von Standard-TS bitte gesondert bestellen.

Standard-WE-Grt. mit K7, mögliche Varianten: K4, K5, K16.

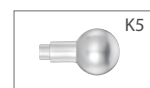

- ◆ Material: Aluminium eloxiert oder Edelstahl matt gebürstet
- ◆ Grundkonstruktion: Stahl
- ◆ Eloxalfarbe: F1 silberfarbig
- ◆ Drücker-Lagerung: fest-drehbar
- ◆ Stütznocken: Stahl Ø 8 mm
- ◆ Verschraubung: M5, verdeckt

		ARTIKELBEZEICHNUNG	DR. FORM	■	ENTF. LOCHUNG	<b>F</b>	BESTELL-NR.	VE
		Kurzschild-Garnitur	108	8 mm	72 mm BB		5608/7201	1 Grt.
		Kurzschild-Garnitur	108	8 mm	72 mm PZ		5608/7203	1 Grt.
		Kurzschild-Garnitur	108	8 mm	78 mm WC		5608/7875	1 Grt.
		Kurzschild-Wechselgarnitur mit Knopf K7	108	8 mm	72 mm PZ		5608/0772	1 Grt.
		FS-Kurzschild-Wechselgarnitur mit Knopf K7	108	9 mm	72 mm PZ	x	5208/0772	1 Grt.
		FS-Kurzschild-Garnitur	108	9 mm	72 mm PZ	x	5208/7203	1 Grt.
		FS-Standflügel-Garnitur einseitig mit Blindschild	108	9 mm	OSL/blind	x	5208/0000	1 Grt.

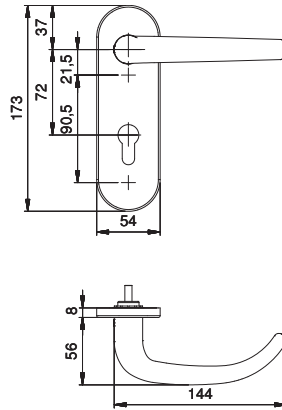

F1	EST

**INFOthek** 

Lieferung incl. Befestigungszubehör für TS 38-58 mm (WC TS 38-48 mm).

Abweichungen von Standard-TS bitte gesondert bestellen.

Standard-WE-Grt. mit K7, mögliche Varianten: K4, K5, K16.

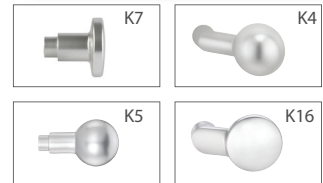

- ◆ Material: Aluminium eloxiert oder Edelstahl matt gebürstet
- ◆ Grundkonstruktion: Stahl
- ◆ Eloxalfarbe: F1 silberfarbig
- ◆ Drücker-Lagerung: fest-drehbar
- ◆ Stütznocken: Stahl Ø 8 mm
- ◆ Verschraubung: M5, verdeckt
- ◆ Fluchttür-Garnitur: geprüft nach **DIN EN 179** in Kombination mit zugelassenen Schlössern (Info.S.21)

		ARTIKELBEZEICHNUNG	DR. FORM	■	ENTF. LOCHUNG			BESTELL-NR.	VE
		Kurzschild-Garnitur	114	8 mm	72 mm BB			5614/7201	1 Grt.
		Kurzschild-Garnitur	114	8 mm	72 mm PZ			5614/7203	1 Grt.
		Kurzschild-Garnitur	114	8 mm	78 mm WC			5614/7875	1 Grt.
		Kurzschild-Wechselgarnitur mit Knopf K7	114	8 mm	72 mm PZ			5614/0772	1 Grt.
		FS-Kurzschild-Wechselgarnitur mit Knopf K7	114	9 mm	72 mm PZ	x	x	5214/0772	1 Grt.
		FS-Kurzschild-Garnitur	114	9 mm	72 mm PZ	x		5214/7203	1 Grt.
		FS-Kurzschild-Fluchttür-Garnitur	114	9 mm	72 mm PZ	x	x	5214/6060	1 Grt.
		FS-Standflügel-Garnitur einseitig mit Blindschild	114	9 mm	OSL/blind	x	x	5214/0000	1 Grt.

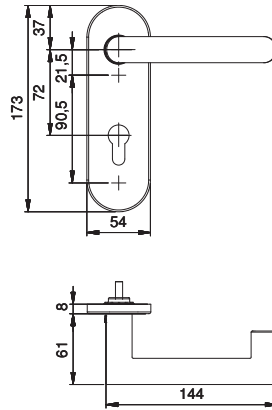

F1	EST

**INFOthek** 

Lieferung incl. Befestigungszubehör für TS 38-58 mm (WC TS 38-48 mm).

Abweichungen von Standard-TS bitte gesondert bestellen.

Standard-WE-Grt. mit K7, mögliche Varianten: K4, K5, K16.

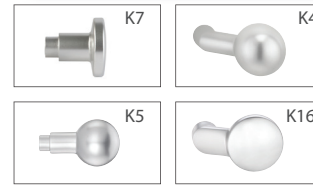

- ◆ Material: Aluminium eloxiert oder Edelstahl matt gebürstet
- ◆ Grundkonstruktion: Stahl
- ◆ Eloxalfarbe: F1 silberfarbig
- ◆ Drücker-Lagerung: fest-drehbar
- ◆ Stütznocken: Stahl Ø 8 mm
- ◆ Verschraubung: M5, verdeckt
- ◆ Fluchttür-Garnitur: geprüft nach **DIN EN 179** in Kombination mit zugelassenen Schlössern (Info.S.21)

		ARTIKELBEZEICHNUNG	DR. FORM	■	ENTF. LOCHUNG			BESTELL-NR.	VE
		Kurzschild-Garnitur	136	8 mm	72 mm BB			5636/7201	1 Grt.
		Kurzschild-Garnitur	136	8 mm	72 mm PZ			5636/7203	1 Grt.
		Kurzschild-Garnitur	136	8 mm	78 mm WC			5636/7875	1 Grt.
		Kurzschild-Wechselgarnitur mit Knopf K7	136	8 mm	72 mm PZ			5636/0772	1 Grt.
		FS-Kurzschild-Wechselgarnitur mit Knopf K7	136	9 mm	72 mm PZ	x	x	5236/0772	1 Grt.
		FS--Kurzschild-Garnitur	136	9 mm	72 mm PZ	x		5236/7203	1 Grt.
		FS-Kurzschild-Fluchttür-Garnitur	136	9 mm	72 mm PZ	x	x	5236/6060	1 Grt.
		FS-Standflügel-Garnitur einseitig mit Blindschild	136	9 mm	OSL/blind	x	x	5236/0000	1 Grt.

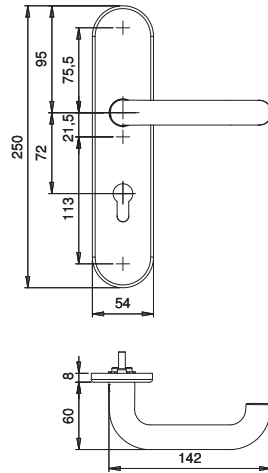

F1	EST

**INFOthek** 





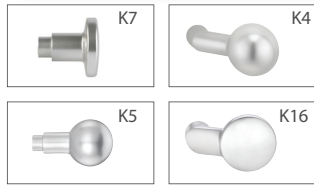

Lieferung incl. Befestigungszubehör für TS 38-58 mm (WC TS 38-48 mm).

Abweichungen von Standard-TS bitte gesondert bestellen.

Standard-WE-Grt. mit K7, mögliche Varianten: K4, K5, K16.

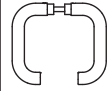

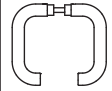
- ◆ Material: Aluminium eloxiert oder Edelstahl matt gebürstet
- ◆ Grundkonstruktion: Stahl
- ◆ Eloxalfarbe: F1 silberfarbig
- ◆ Drücker-Lagerung: fest-drehbar
- ◆ Stütznocken: Stahl Ø 8 mm
- ◆ Verschraubung: M5, verdeckt
- ◆ Fluchttür-Garnitur: geprüft nach **DIN EN 179** in Kombination mit zugelassenen Schlössern (Info.S.21)

		ARTIKELBEZEICHNUNG	DR. FORM	■	ENTF. LOCHUNG			BESTELL-NR.	VE
		Langschild-Garnitur	103	8 mm	72 mm BB			5803/7201	1 Grt.
		Langschild-Garnitur	103	8 mm	72 mm PZ			5803/7203	1 Grt.
		Langschild-Garnitur	103	8 mm	78 mm WC			5803/7875	1 Grt.
		Langschild-Wechselgarnitur mit Knopf K7	103	8 mm	72 mm PZ			5803/0772	1 Grt.
		FS-Langschild-Wechselgarnitur mit Knopf K7	103	9 mm	72 mm PZ	x	x	5303/0772	1 Grt.
		FS-Langschild-Garnitur	103	9 mm	72 mm PZ	x		5303/7203	1 Grt.
		FS-Langschild-Fluchttür-Garnitur	103	9 mm	72 mm PZ	x	x	5303/6060	1 Grt.
		FS-Standflügel-Garnitur einseitig mit Blindschild	103	9 mm	OSL/blind	x	x	5303/0000	1 Grt.

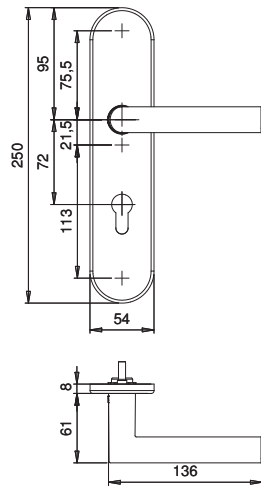

F1	EST

**INFOthek**



Lieferung incl. Befestigungszubehör für TS 38-58 mm (WC TS 38-48 mm).

Abweichungen von Standard-TS bitte gesondert bestellen.

Standard-WE-Grt. mit K7, mögliche Varianten: K4, K5, K16.



- ◆ Material: Aluminium eloxiert oder Edelstahl matt gebürstet
- ◆ Grundkonstruktion: Stahl
- ◆ Eloxalfarbe: F1 silberfarbig
- ◆ Drücker-Lagerung: fest-drehbar
- ◆ Stütznocken: Stahl Ø 8 mm
- ◆ Verschraubung: M5, verdeckt

		ARTIKELBEZEICHNUNG	DR. FORM	■	ENTF. LOCHUNG	F	BESTELL-NR.	VE
		Langschild-Garnitur	108	8 mm	72 mm BB		5808/7201	1 Grt.
		Langschild-Garnitur	108	8 mm	72 mm PZ		5808/7203	1 Grt.
		Langschild-Garnitur	108	8 mm	78 mm WC		5808/7875	1 Grt.
		Langschild-Wechselgarnitur mit Knopf K7	108	8 mm	72 mm PZ		5808/0772	1 Grt.
		FS-Langschild-Wechselgarnitur mit Knopf K7	108	9 mm	72 mm PZ	x	5308/0772	1 Grt.
		FS--Langschild-Garnitur	108	9 mm	72 mm PZ	x	5308/7203	1 Grt.
		FS-Standflügel-Garnitur einseitig mit Blindschild	108	9 mm	OSL/blind	x	5308/0000	1 Grt.

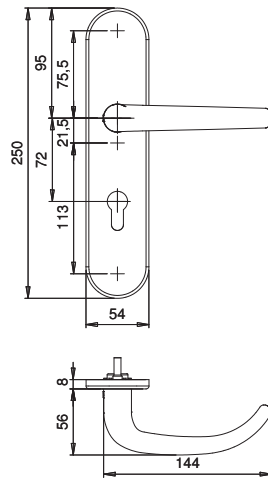

F1	EST

**INFOthek** 



Lieferung incl. Befestigungszubehör für TS 38-58 mm (WC TS 38-48 mm).

Abweichungen von Standard-TS bitte gesondert bestellen.

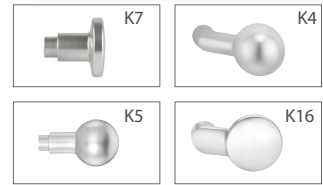
Standard-WE-Grt. mit K7, mögliche Varianten: K4, K5, K16.

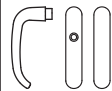

- ◆ Material: Aluminium eloxiert oder Edelstahl matt gebürstet
- ◆ Grundkonstruktion: Stahl
- ◆ Eloxalfarbe: F1 silberfarbig
- ◆ Drücker-Lagerung: fest-drehbar
- ◆ Stütznocken: Stahl Ø 8 mm
- ◆ Verschraubung: M5, verdeckt
- ◆ Fluchttür-Garnitur: geprüft nach **DIN EN 179** in Kombination mit zugelassenen Schlössern (Info.S.21)

		ARTIKELBEZEICHNUNG	DR. FORM	■	ENTF. LOCHUNG			BESTELL-NR.	VE
		Langschild-Garnitur	114	8 mm	72 mm BB			5814/7201	1 Grt.
		Langschild-Garnitur	114	8 mm	72 mm PZ			5814/7203	1 Grt.
		Langschild-Garnitur	114	8 mm	78 mm WC			5814/7875	1 Grt.
		Langschild-Wechselgarnitur mit Knopf K7	114	8 mm	72 mm PZ			5814/0772	1 Grt.
		FS-Langschild-Wechselgarnitur mit Knopf K7	114	9 mm	72 mm PZ	x	x	5314/0772	1 Grt.
		FS-Langschild-Garnitur	114	9 mm	72 mm PZ	x		5314/7203	1 Grt.
		FS-Langschild-Fluchttür-Garnitur	114	9 mm	72 mm PZ	x	x	5314/6060	1 Grt.
		FS-Standflügel-Garnitur einseitig mit Blindschild	114	9 mm	OSL/blind	x	x	5314/0000	1 Grt.

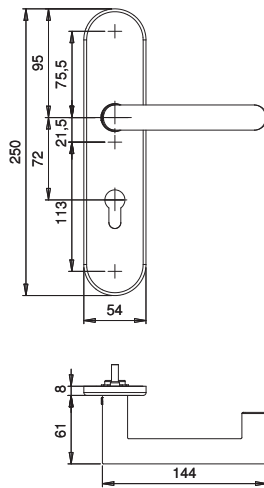

F1	EST

**INFOthek**



Lieferung incl. Befestigungszubehör für TS 38-58 mm (WC TS 38-48 mm).

Abweichungen von Standard-TS bitte gesondert bestellen.

Standard-WE-Grt. mit K7, mögliche Varianten: K4, K5, K16.



- ◆ Material: Aluminium eloxiert oder Edelstahl matt gebürstet
- ◆ Grundkonstruktion: Stahl
- ◆ Eloxalfarbe: F1 silberfarbig
- ◆ Drücker-Lagerung: fest-drehbar
- ◆ Stütznocken: Stahl Ø 8 mm
- ◆ Verschraubung: M5, verdeckt
- ◆ Fluchttür-Garnitur: geprüft nach **DIN EN 179** in Kombination mit zugelassenen Schließern (Info.S.21)

		ARTIKELBEZEICHNUNG	DR. FORM	■	ENTF. LOCHUNG			BESTELL-NR.	VE
		Langschild-Garnitur	136	8 mm	72 mm BB			5836/7201	1 Grt.
		Langschild-Garnitur	136	8 mm	72 mm PZ			5836/7203	1 Grt.
		Langschild-Garnitur	136	8 mm	78 mm WC			5836/7875	1 Grt.
		Langschild-Wechselgarnitur mit Knopf K7	136	8 mm	72 mm PZ			5836/0772	1 Grt.
		FS-Langschild-Wechselgarnitur mit Knopf K7	136	9 mm	72 mm PZ	x	x	5336/0772	1 Grt.
		FS--Langschild-Garnitur	136	9 mm	72 mm PZ	x		5336/7203	1 Grt.
		FS-Langschild-Fluchttür-Garnitur	136	9 mm	72 mm PZ	x	x	5336/6060	1 Grt.
		FS-Standflügel-Garnitur einseitig mit Blindschild	136	9 mm	OSL/blind	x	x	5336/0000	1 Grt.



## 6.2 MONTAGESETS SERIEN RIVA, TARGA/K + TARGA/L

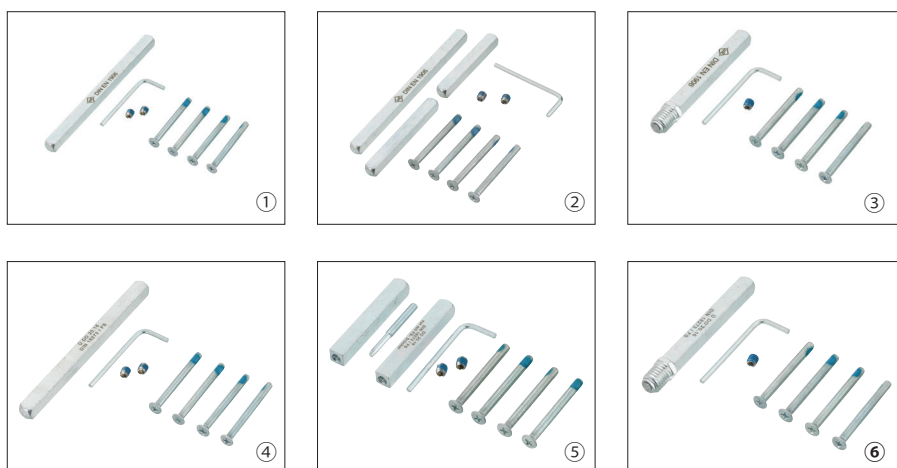

### INFOthek



Standardmäßig liefern wir zu allen Objektbeschlägen Montagesets für:  
 ZT TS 38-58 mm  
 WC TS 38-48 mm

Abweichende Türstärken bei DR-Garnituren immer bei der Bestellung mit angeben. Die nachstehende Auflistung bezieht sich auf Montagesets bei abweichenden Türstärken für WE-Garnituren und FS-DR-Garnituren.

alle Maßangaben in mm. Die Montagesets Serie TARGA beinhalten 3 Senkkopfschrauben, sonst wie oben abgebildet.

SERIE RIVA		DR.-DR-GARNITUREN 8 MM SCHLOSSNUSS ①		WC-GARNITUREN 8 MM SCHLOSSNUSS ②		WECHSEL-GARNITUREN 8 MM SCHLOSSNUSS ③	
Türstärke	4 Senkkopfschrauben	■ Stift M	Bestell-Nr. Set	■ Stift M	Bestell-Nr. Set	■ Stift OM	Bestell-Nr. Set
38-58	M5 x 50	8 x 120	9000/0550	8 x 120	9000/0553	8 x 75	9000/0551
58-78	M5 x 70	8 x 140	9000/0560	8 x 140	9000/0563	8 x 95	9000/0561
SERIE RIVA FS		DR.-DR-GARNITUREN 9 MM SCHLOSSNUSS ④		FLUCHTTÜR-GARNIT. 9 MM SCHLOSSNUSS ⑤		WECHSEL-GARNITUREN 9 MM SCHLOSSNUSS ⑥	
Türstärke	4 Senkkopfschrauben	■ Stift MF	Bestell-Nr. Set	■ Stift Q	Bestell-Nr. Set	■ Stift OMF	Bestell-Nr. Set
38-58	M5 x 50	9 x 120	9000/0500	9x60/60	9000/0502	9 x 75	9000/0501
58-78	M5 x 70	9 x 140	9000/0510	9x60/60	9000/0512	9 x 95	9000/0511
SERIE TARGA/K + TARGA/L		DR.-DR-GARNITUREN 8 MM SCHLOSSNUSS ①		WC-GARNITUREN 8 MM SCHLOSSNUSS ②		WECHSEL-GARNITUREN 8 MM SCHLOSSNUSS ③	
Türstärke	3 Senkkopfschrauben	■ Stift M	Bestell-Nr. Set	■ Stift M	Bestell-Nr. Set	■ Stift OM	Bestell-Nr. Set
38-58	M5 x 50	8 x 120	9000/0750	8 x 120	9000/0753	8 x 80	9000/0751
58-73	M5 x 70	8 x 140	9000/0760	8 x 140	9000/0763	8 x 95	9000/0761
SERIE TARGA/K + TARGA/L FS		DR.-DR-GARNITUREN 9 MM SCHLOSSNUSS ④		FLUCHTTÜR-GARNIT. 9 MM SCHLOSSNUSS ⑤		WECHSEL-GARNITUREN 9 MM SCHLOSSNUSS ⑥	
Türstärke	3 Senkkopfschrauben	■ Stift MF	Bestell-Nr. Set	■ Stift Q	Bestell-Nr. Set	■ Stift OMF	Bestell-Nr. Set
38-58	M5 x 50	9 x 120	9000/0700	9x60/60	9000/0702	9 x 75	9000/0701
58-73	M5 x 70	9 x 140	9000/0710	9x60/60	9000/0712	9 x 95	9000/0711

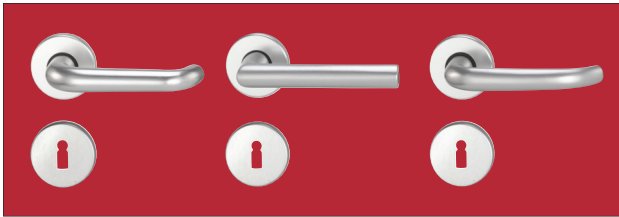

Konsequent integriert sich die SERIE INDIA als zertifizierter **Klasse 3-Beschlag** in das Segment der geprüften Edelstahl-Beschläge, rundet damit die Design-Linie mit dieser Klasse ab...



... und ermöglicht damit die Kombination verschiedener Anforderungen im Objektbereich, auch hinsichtlich Feuerschutz und Panik aus der Serie RIVA.

Die moderne Stilrichtung des klar gezeichneten Beschlag-Designs der Klasse 4-Beschläge bleibt erhalten und sichert höchsten Qualitätsstandard auch im Bereich der Serie INDIA Klasse 3.

Ergänzt wird das Modul wiederum durch passende Fenstergriffe, Schutzgarnituren und/oder Rahmen-türbeschläge.

Diese Flexibilität erleichtert Ihre Lagerhaltung und senkt damit die Kosten.

Die optische Wertigkeit dieser Garnituren wird hervorgehoben durch die Rosetten mit einem Durchmesser von 55 mm und der besonderen Drückersstärke der Modelle U-Form und Gehrung.

Die fest-drehbare Lagerung der Garnituren, unterstützt durch die zusätzliche Madenschraube im Drücker, garantieren einen stabilen Sitz auf dem Türblatt.

						<b>Klassifizierungsschlüssel</b>							
DIN EN 1906			EST		→	3	7	-	0	0	0	O	A

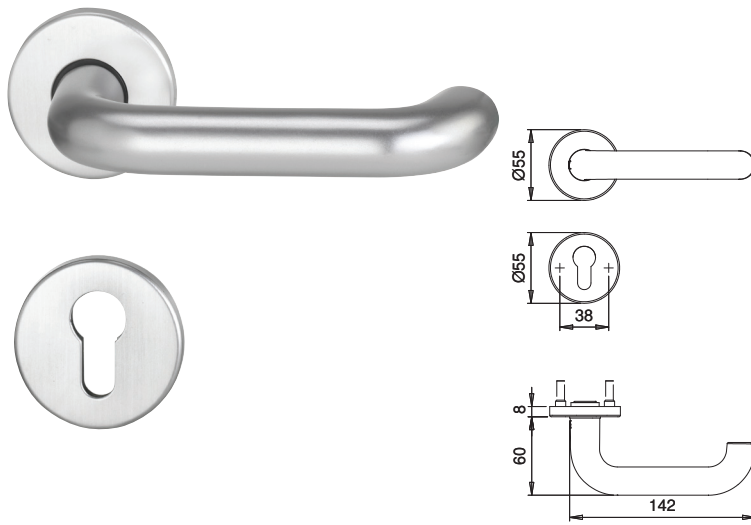

EST	

**INFOthek**

Lieferung incl. Befestigungszubehör für TS 38-58 mm (WC TS 38-48 mm).

Serie India in Alu F01 auf Anfrage.



- ◆ Material: Edelstahl matt gebürstet
- ◆ Grundkonstruktion: Kunststoff
- ◆ Rosetten-Ø: 55 mm
- ◆ Drücker-Lagerung: fest-drehbar, mit Hochhaltefeder
- ◆ Stütznocken: Ø 7 mm
- ◆ Verschraubung: M5, verdeckt, Hülsenschrauben

		ARTIKELBEZEICHNUNG	DR. FORM	■	LOCHUNG		BESTELL-NR.	VE
		Rosetten-Garnitur	103Z	8 mm	BB		3103/8501	1 Grt.
		Rosetten-Garnitur	103Z	8 mm	PZ		3103/8603	1 Grt.
		Rosetten-Garnitur	103Z	8 mm	WC		3103/8704	1 Grt.
		Rosetten-Wechselgarnitur mit Knopf K7	103Z	8 mm	PZ		3103/0786	1 Grt.

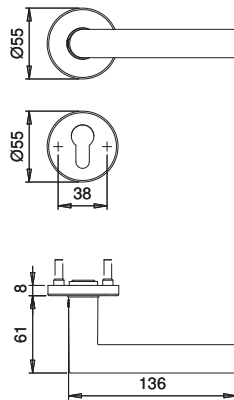

EST	

**INFOthek**



Lieferung incl. Befestigungszubehör für TS 38-58 mm (WC TS 38-48 mm).

Serie India in Alu F01 auf Anfrage.

- ◆ Material: Edelstahl matt gebürstet
- ◆ Grundkonstruktion: Kunststoff
- ◆ Rosetten-Ø: 55 mm
- ◆ Drücker-Lagerung: fest-drehbar, mit Hochhaltefeder
- ◆ Stütznocken: Ø 7 mm
- ◆ Verschraubung: M5, verdeckt, Hülsenschrauben

		ARTIKELBEZEICHNUNG	DR. FORM	■	LOCHUNG		BESTELL-NR.	VE
		Rosetten-Garnitur	108Z	8 mm	BB		3108/8501	1 Grt.
		Rosetten-Garnitur	108Z	8 mm	PZ		3108/8603	1 Grt.
		Rosetten-Garnitur	108Z	8 mm	WC		3108/8704	1 Grt.
		Rosetten-Wechselgarnitur mit Knopf K7	108Z	8 mm	PZ		3108/0786	1 Grt.

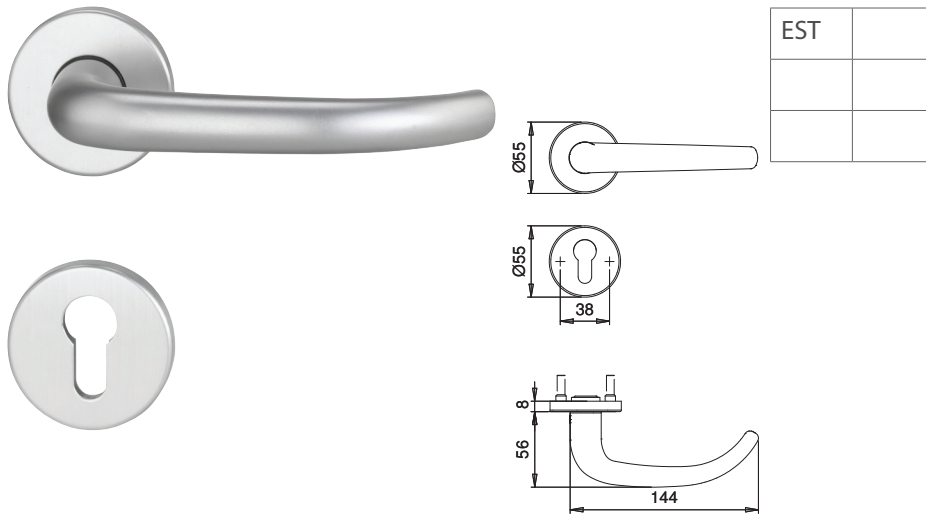

**INFOthek**

Lieferung incl. Befestigungszubehör für TS 38-58 mm (WC TS 38-48 mm).

Serie India in Alu F1 auf Anfrage.



- ◆ Material: Edelstahl matt gebürstet
- ◆ Grundkonstruktion: Kunststoff
- ◆ Rosetten-Ø: 55 mm
- ◆ Drücker-Lagerung: fest-drehbar, mit Hochhaltefeder
- ◆ Stütznocken: Ø 7 mm
- ◆ Verschraubung: M5, verdeckt, Hülsenschrauben

		ARTIKELBEZEICHNUNG	DR. FORM	■	LOCHUNG		BESTELL-NR.	VE
		Rosetten-Garnitur	114Z	8 mm	BB		3114/8501	1 Grt.
		Rosetten-Garnitur	114Z	8 mm	PZ		3114/8603	1 Grt.
		Rosetten-Garnitur	114Z	8 mm	WC		3114/8704	1 Grt.
		Rosetten-Wechselgarnitur mit Knopf K7	114Z	8 mm	PZ		3114/0786	1 Grt.

**edi** | Alles aus einer Hand



Erich Dieckmann GmbH  
Grüner Talstraße 18 - 22  
58644 Iserlohn

Tel : +49 02371 956-0  
Fax: +49 02371 956-120  
Mail: [info@dieckmann.com](mailto:info@dieckmann.com)